



Sectional Garage Doors

Thermal insulation, security and comfort for your garage

HÖRMANN





CONTENT

4	Advice
8	Good reasons to try Hörmann
18	Advice
20	Overview of steel sectional doors
24	Overview of solid timber sectional doors
26	Overview of steel surface finishes and types of timber
28	General overview
32	Advice
34	Door styles
48	Colour
54	Manual release
56	Glazings
58	Wicket doors
60	Side doors
64	Modernise and improve
70	Garage door operators
74	Accessories
80	Technology
86	Performance characteristics
88	Dimensions and fitting data

Some of the doors shown are equipped with optional extras and do not always correspond to our standard models.

The surface finishes and colours shown are subject to the limitations of the printing process and cannot be regarded as binding.

All rights reserved. No part may be reproduced without our prior permission. Subject to changes.

The sectional door – which one is right for me?

There are several aspects to consider when deciding on a new sectional garage door. The days of boring, functional metal doors are long gone. A huge choice of sectional doors that combine function, appearance and security is now available. We have compiled compact information on all important garage door details, to ensure you can concentrate on the essentials when purchasing a door.

Material – steel or timber?

The typical materials for garage doors are timber and steel. **Steel garage doors are heavy-duty and durable.** Rain runs off without leaving any streaky marks thanks to the use of hot-galvanized material and a high-quality polyester-primer coating on both sides, which also protects against rust. Steel sectional doors are insulated with a rating of good to very good, offer countless design possibilities and are very easy to clean.

Real timber garage doors are available in various designs and **go very well with houses featuring lots of timber elements.** Because wood is a natural resource, timber garage doors require lots of care and are comparatively expensive. Regular care of timber garage doors is therefore particularly important to protect the wood in the long-term.

The facade door is a particular highlight amongst garage doors, because it can be panelled in the material of the house facade and therefore almost invisibly integrated in the building design.

Thermal insulation – why is it important?

The subject of **insulation is particularly important when the garage is connected directly to the house** or is used as a workshop or hobby room. Double-skinned sectional doors have very good thermal insulation properties. The door action is also very quiet thanks to the sturdy door leaf. Additional plastic profiles with extra seals minimise the thermal bridge between the wall and frame. These kinds of profiles **can improve the insulation by a further 15 percent.**

Operators – what are the advantages?

Garage door operators are now almost always standard equipment on garage doors. Automatically operated garage doors offer the advantage **that the garage door can be operated particularly conveniently with the hand transmitter directly from the car.** Smart Home solutions mean it is now possible to open garage doors at any time and from anywhere using a smartphone. Operators also offer increased **protection against break-ins** because a lock means they cannot be lifted up when the door is closed. Attention should be paid to an anti-lift kit that also works in case of power failure.

Garage entrances – which doors are available?

A door integrated in the garage door is recommended if the garage is not directly accessible from the house. So-called wicket doors are practical because **the garage door does not need to be fully opened every time**, for example if you need a bike. The wicket door should have a low threshold rail to minimise the risk of tripping. For large garages, a garage side door without a threshold rail can also be used.



▲ A practical wicket door means you can retrieve bicycles from your garage without opening the door fully.

▼ Double-skinned sectional doors with high thermal insulation are recommended if your garage is also used as a hobby room.



Benefit from numerous advantages

Sectional doors open vertically upwards and are suspended under the ceiling to save space. This construction principle means you can make full use of the space inside and in front of the garage. Sectional garage doors can be fitted in any garage opening and offer up to 14 cm more passage width than up-and-over doors. They are also optimally sealed with flexible and weather-resistant seals on all four sides.

Treat yourself to this comfort and convenience.





“A good reputation must be earned.”

August Hörmann

In line with the founder's philosophy, the Hörmann brand today is a true promise of quality. The family-owned company has over 80 years of experience in door and operator construction and, with sales of over 20 million doors, is no. 1 in Europe. This makes a Hörmann sectional door a reassuring purchase.



1 Brand quality “Made in Germany”

All essential doors and operator components are developed and manufactured by Hörmann, are **perfectly matched to each other** and **tested and certified** by independent, recognised institutes to ensure your safety. They are manufactured in Germany according to the DIN ISO 9001 quality management system and meet the requirements of European standard 13241-1. Furthermore, our highly qualified employees work intensively on new products, continual further developments and improvements to details. The results are patents and one-of-a-kind products you can depend on.

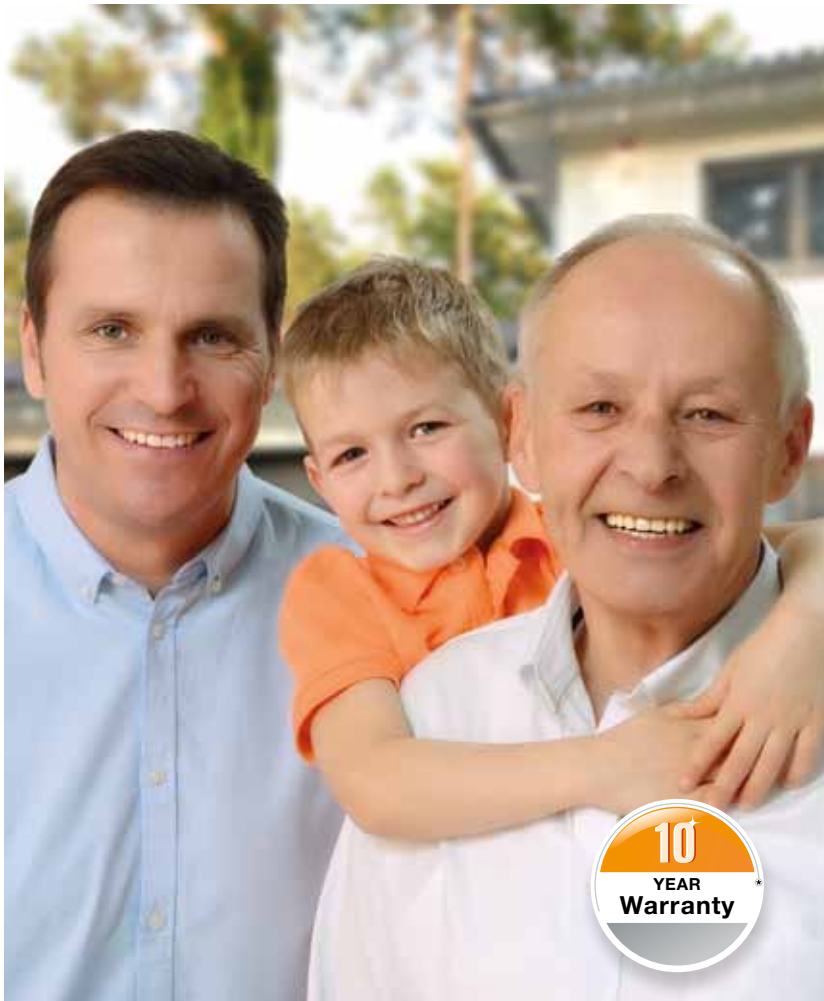

2 Garage doors for generations

Endurance tests under real-life conditions ensure mature series products with Hörmann quality. Thanks to this, as well as excellent technical solutions and uncompromising quality assurance, you receive a **10-year warranty on all Hörmann sectional doors and a 5-year warranty on Hörmann operators.***

* The complete warranty conditions can be found at: www.hormann.co.uk

3 An eye on the future

Hörmann is setting a good example. This is why the company obtains **100 % of its required energy from green sources.** At the same time, many tonnes of CO₂ are saved each year thanks to the introduction of an intelligent and certified energy management system. And last but not least, Hörmann also offers products for sustainable construction.

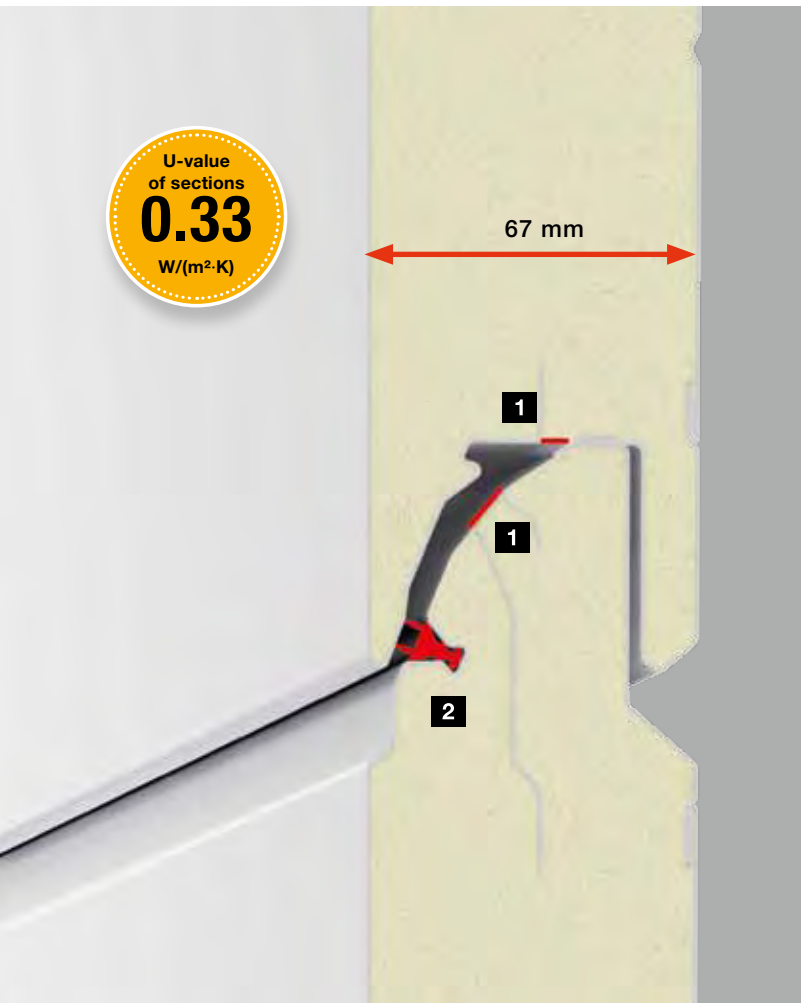

4 Modern energy-saving door

Double-skinned sectional doors are particularly recommended for garages attached directly to the house. In addition to the LPU 42 with very good thermal insulation, the **LPU 67 Thermo** offers everything that is expected from modern construction: **excellent thermal insulation achieved by sections with a thermal break 1** with a U-value of 0.33 W/(m²·K)*, a very good seal on spaces between sections with double lip seals **2** and an optimum floor connection using double bottom seals, which also compensate for floor unevenness and energy losses.

* U-value of door (5000 x 2125 mm): 1.0 W/(m²·K)

5 Efficient thermal insulation

! Only from Hörmann

With the **Hörmann ThermoFrame** you can improve the already high insulation values, especially of the double-skinned sectional doors. The black plastic profile is fitted together with the door frame. **Insulation is improved by 15 %**** thanks to the thermal break between the frame and brickwork. The optional ThermoFrame frame connection is available for all Hörmann sectional doors.

** For a double-skinned sectional garage door LPU 42 size 5000 x 2125 mm



6 Optimum long-term protection

! Only from Hörmann

A non-brittle, 4 cm **plastic frame shoe** covers the frame where it is prone to rusting and offers **long-term protection against corrosion**, even with waterlogging, which is unmatched by competitor solutions.

Together with the door's bottom seal, the frame shoe makes for a bottom edge that is visually appealing.

7 Exclusive interior door view

If you use your garage as a hobby room, you also want a harmonious door view in the garage. **The premium version of the LPU 67 Thermo** meets these precise demands: the full frame***, the tracks and connection rails and all fittings are available in Grey white RAL 9002, matching the inside of the door leaf. **The door thereby blends harmoniously into the interior** and adds value to your garage. The tandem track rollers also mean that your door runs very quietly and smoothly.

*** Outside view of the frame in Grey white RAL 9002, meaning that a frame covering is recommended for doors in Traffic white RAL 9016.



8 A harmonious overall appearance



Only from Hörmann

in all door sizes

1 Even spacing and invisible section transitions for ribbed doors

Hörmann garage doors are distinguished by even, exact spacing of sections [A]. The sections are shaped so that the transitions are practically invisible when the door is closed. See for yourself!

To add to the overall appearance, a practical side door with an alignment matching the sectional garage doors is also available. For further information, see pages 60 – 63.

2 Irregular spacing of sections [B], [C] due to different section heights coupled with visible section transitions on competitor doors. This gives the door an uneven look.

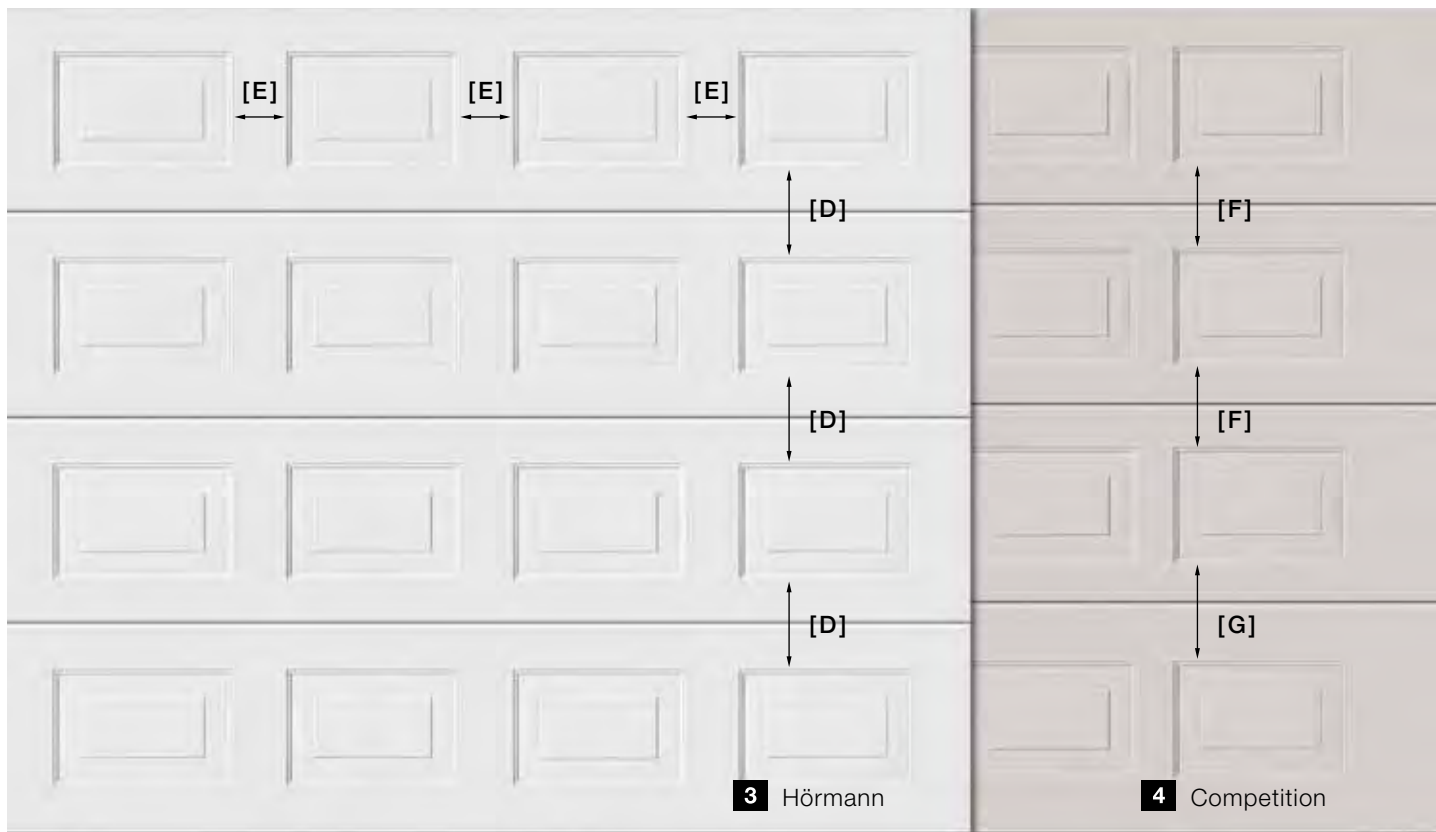

Only from Hörmann in all door sizes

3 Uniformly divided panelled doors

To create a harmonious overall appearance, the height of the spaces between the individual panels **[D]** of Hörmann sectional doors is exactly even. This is achieved by using sections with the same height across the entire door height. The horizontal spacing between the panels within a section **[E]** is also uniform. This gives the doors an even appearance.

On request, side doors are also available with the same section spacing as the sectional garage door. For further information, see pages 60 – 63.

4 Irregular panel spacing [F], [G] due to different section heights on competitor doors. This gives the door an uneven look.

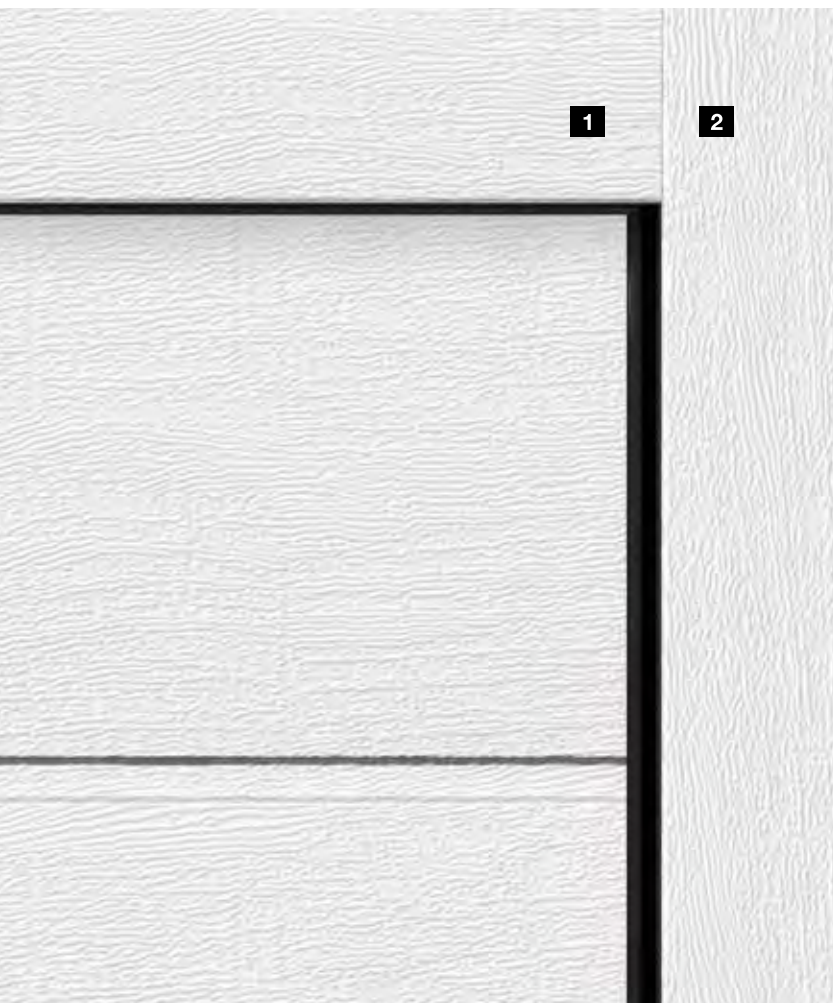

9 Matching appearance of frames and door leaves

! Only from Hörmann

The **harmonious appearance of a door** is the result of many small details: For white doors and all surface finishes, the fascia panel **1** is always provided matching the door sections. This ensures that everything fits together. The side frames **2** are available with a white Woodgrain surface finish* as standard. For sectional doors with the surface finishes Sandgrain, Silkgrain or Decograin as well as coloured doors, the frame coverings are optionally available in the surface finish of the door section. For Micrograin doors, the frame covering is provided with a smooth Silkgrain surface finish.

For further information, please see page 66.

* For LPU 67 Thermo in the premium version in Grey white RAL 9002

10 Flush-fitting fascia panels

For LPU 42 doors, a flush-fitting fascia panel is the **most elegant solution for an invisible transition** between the panel and door leaf. When the door is closed, the top door section is flush with the panel.

For further information, please see page 68.

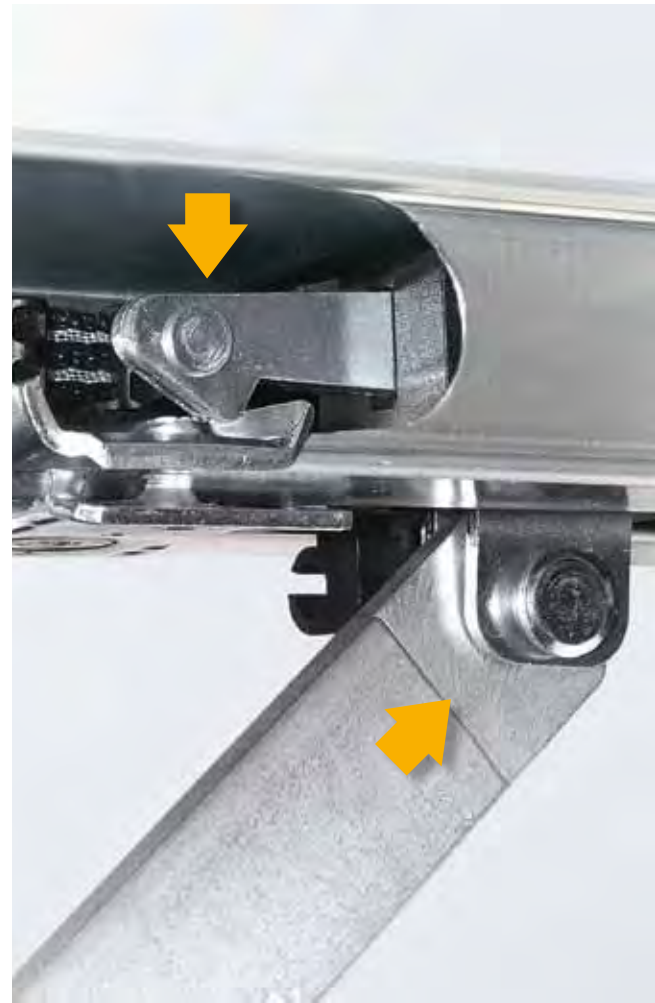

11

Practical solutions

! Only from Hörmann

An LPU 42 door with wicket doors are recommended for easy passage **with a trip-free threshold** into your garage. You can also retrieve bicycles or gardening equipment from your garage without opening the door.

The stainless steel threshold is only 10 mm in the centre and 5 mm high at the sides. This makes it easier to wheel things through and reduces the risk of tripping up.

For further information, see pages 58 – 59.

12

More security, of course

! Only from Hörmann

Mechanical anti-lift kit in the operator boom

Uninvited guests barely stand a chance with Hörmann's automatic sectional doors. When the garage door is closed, the **anti-lift kit** automatically engages in the operator boom's stop, then **locks immediately and is secured against forced opening**. This patented door locking functions purely mechanically and, in contrast to competitor operators, continues to secure the door even when the power fails.



Take a look at the video at:
www.hormann.co.uk/videos



13

BiSecur radio system with certified security

 **Only from Hörmann**

The bi-directional BiSecur radio system is based on **future-oriented technology** for the convenient and secure operation of garage and entrance gate operators, door operators, lighting and more. The extremely secure BiSecur encryption protocol, developed by Hörmann, with a stable, interference-free range makes sure that no-one can copy your radio signal. It was tested and certified by security experts at Bochum University.



Take a look at the video at:
www.hormann.co.uk/videos

Perfectly matched and 100 % compatible

All BiSecur operators, receivers and control elements are 100 % compatible. Using a hand transmitter or radio code switch, for example, you can conveniently operate your garage door as well as an entrance gate equipped with a Hörmann operator, your door operators or other devices with BiSecur receivers.

With our app* and Hörmann BiSecur gateway, it is easy to control your Hörmann garage door or entrance gate operators, Hörmann entrance door** or the internal door operator PortaMatic as well as other devices **using your smartphone or tablet.**

* For smartphones or tablets with iOS or Android operating systems

** To use this function it is required that your Hörmann entrance door ThermoCarbon/ ThermoSafe is equipped with the automatic lock S5/ S7 Smart.



14 Convenient querying of the door position

You no longer have to go out in any wind and weather to check if your door is closed. At the press of a button, the colour of the LED on the hand transmitter HS 5 BS or the internal push button FIT 5 BS indicates the position of the door. If required, another push of a button*** closes the door. It is the most comfortable and secure way to control your door.

*** An additional photocell is required for operation without visual contact to the door.

15 Award-winning design

In addition to a black or white design, the **exclusive BiSecur hand transmitters** are characterised by an elegant shape that fits easily in the palm of your hand.

Hörmann's BiSecur hand transmitters with an optional high-gloss surface in a piano lacquer look have received the reddot design award for their exclusive design.



Take a look at the video at:
www.hormann.co.uk/videos

Figure above: hand transmitter HS 5 BS with hand transmitter station (optional)

5 reasons why garage door fitting should be left to the professionals

Bent doors, squeaky hinges, slow door opening – a lack of advice and mistakes when fitting the garage door yourself quickly spoil the pleasure of having a new door and could even cause serious injuries. If you want your door fitted quickly ready for use, and you don't feel that you're a talented handyman, you should ask the professionals. Trained specialist staff know about the different kinds of garage doors, offer good advice and professionally fit all components of the door.





▲ Your Hörmann partner will ensure proper disposal of your old garage door.

Finding the right materials for wall fitting

The right **screws, plugs and equipment, such as drills, to suit the wall type** need to be selected before the garage door can be fitted. This depends on whether the wall is made of concrete or is steel-reinforced, for example. Because garage doors produce a high pull and push force when they are opened or closed, it is particularly important that the guide rails are fixed to the wall with the right materials.

Fitting accessories, such as automatic operators

Automatic operators are an essential part of modern garage doors. **Operators should be considered directly during planning** so that they have space on the garage ceiling and form a unit with the door. Specialist partners can best judge which operators are suitable for which door. If you want to be sure that all parts are in the right place and that important safety functions including the automatic safety cut-out work properly, you should contact the professionals, such as the Hörmann sales partners.

Disposing of old garage door parts correctly

After fitting of the new garage door, **proper and environmentally-friendly disposal** of the old door is important. Please note that especially old timber doors are not allowed to be simply used as fire wood, because they have usually been painted several times over the years. Old steel garage doors also have to be disposed of properly. Independent disposal with local waste disposal companies is usually complicated and expensive.

Hörmann sales partners also take care of this step for you and take the old door away after removal.

Dismantling the old garage door for renovation

The old door generally has to be removed before the new garage door can be fitted. **However, take care when dismantling the door leaf.** These can cause serious injuries because the door tension springs on up-and-over doors are under high tension or the door leaves could fall over. Anyone changing from an up-and-over door to a sectional door, for example, also needs to remove the wall and ceiling fixing so that the new components of the garage door can be fitted.

Measuring the door opening

Accuracy when measuring is important so that the door fits the garage opening. Gradients need to be considered in some cases or the ceiling height of the garage is not sufficient to simply fit a new door. Older garages often have special dimensions that need to be observed and require special solutions. Incorrect measurement of the frame position can also be another problem when taking measurements. If the frame is fitted incorrectly, the garage door is difficult to open, makes noises when it is opened and closed or doesn't open in the first place. **Specialist partners take the measurements so that you don't need to worry about the right dimensions.** This means you can be sure of receiving the door to suit your needs, which fits perfectly in the garage opening when it is installed.

◀ Removal of the old door and fitting of the new garage door usually take place within one day.

LPU 67 Thermo

The energy-saving door impresses thanks to 67-mm-thick sections with thermal break achieving excellent thermal insulation.

LPU 42

The double-skinned LPU 42 door offers very good insulation with its 42-mm-thick sections.

LTE 42

The single-skinned LTE 42 door is the inexpensive solution for detached garages that do not require additional thermal insulation.



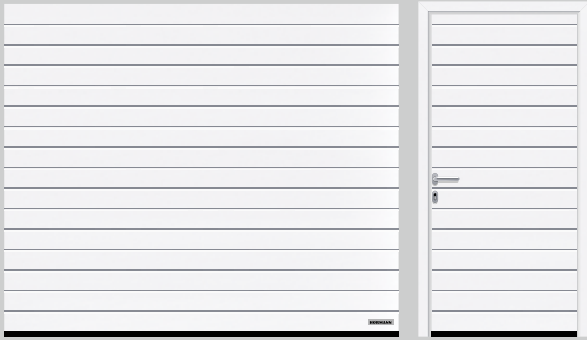

S-ribbed (LPU 42, LTE 42), Traffic white RAL 9016



M-ribbed (LPU 67 Thermo, LPU 42, LTE 42), Traffic white RAL 9016

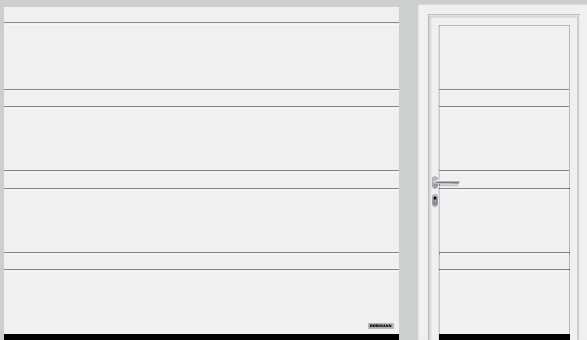

D-ribbed (LPU 42), Traffic white RAL 9016



T-ribbed (LPU 42), Traffic white RAL 9016



L-ribbed (LPU 67 Thermo, LPU 42), Traffic white RAL 9016



Panelled (LPU 42, LTE 42), Traffic white RAL 9016

Note

All door styles (LPU 67 Thermo, LPU 42) are also available with wicket door. For further information, see pages 58 – 59.

OVERVIEW OF STEEL SECTIONAL DOORS



L-ribbed (LPU 67 Thermo, LPU 42), design element style 450, Traffic white RAL 9016



L-ribbed (LPU 67 Thermo, LPU 42), design element style 456, Traffic white RAL 9016

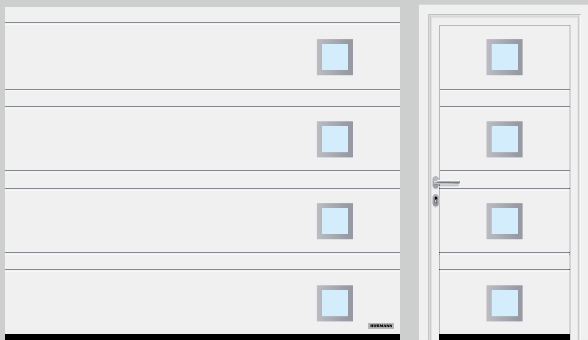

D-ribbed (LPU 67 Thermo, LPU 42), style 461 with glazing, Traffic white RAL 9016

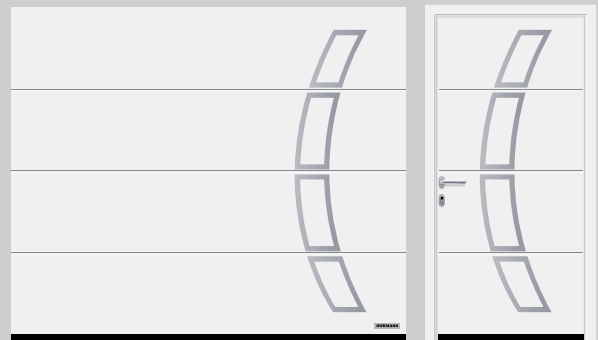

L-ribbed (LPU 67 Thermo, LPU 42), design element style 457, Traffic white RAL 9016



T-ribbed (LPU 67 Thermo, LPU 42), inlay element style 501 in stainless steel look, design element style 454, Traffic white RAL 9016

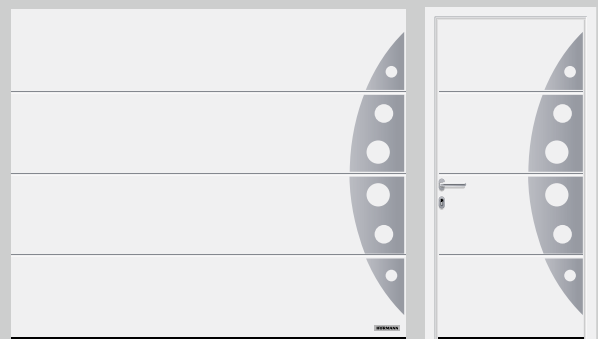

L-ribbed (LPU 67 Thermo, LPU 42), design element style 458, Traffic white RAL 9016

You can arrange the design elements as shown above or individually.



Style 451



Style 461



Style 452



Style 462



Style 471



Style 481



Style 459



Style 469



Style 453 ■ NEW



Style 463 ■ NEW



Style 455 ■ NEW



Style 460 ■ NEW



Style 472 ■ NEW



Style 482 ■ NEW



Style 473 ■ NEW

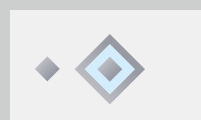

Style 483 ■ NEW



Style 474 ■ NEW



Style 475 ■ NEW

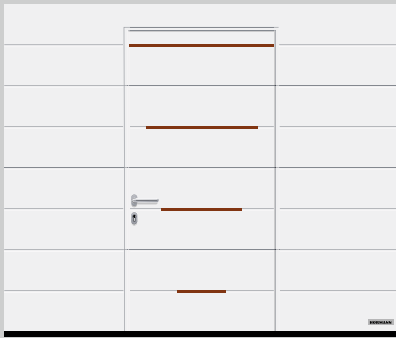

M-ribbed (LPU 42), inlay element style 504 ■ **NEW**
in timber look, in the wicket door, Traffic white RAL 9016

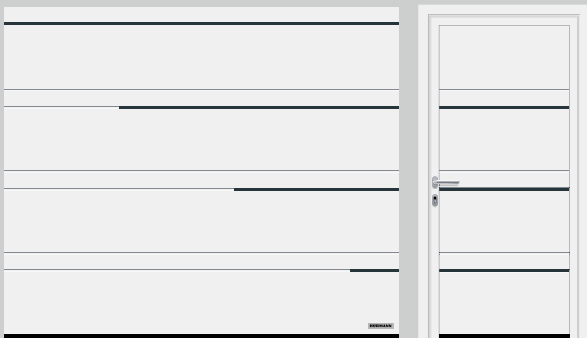

D-ribbed (LPU 42), inlay element style 502 ■ **NEW**
in Anthracite grey RAL 7016, Traffic white RAL 9016

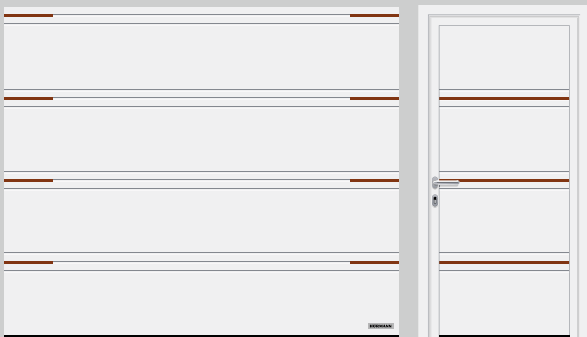

T-ribbed (LPU 42), inlay element style 500 with divided inlays in timber look,
Traffic white RAL 9016

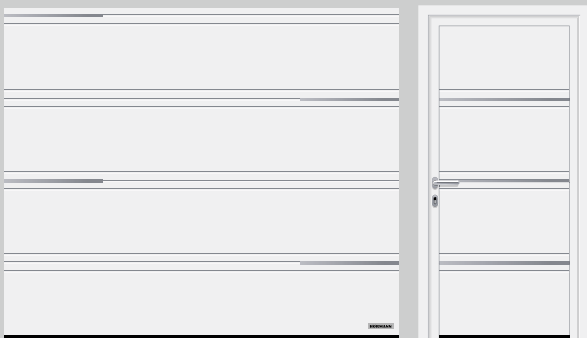

T-ribbed (LPU 42) inlay element style 503 ■ **NEW**
in stainless steel look, Traffic white RAL 9016

Individual design styles

You can individually position and combine the design elements on your door to create your own door style. Doors with a wicket door are also available with design elements. Your Hörmann partner would be pleased to advise you.

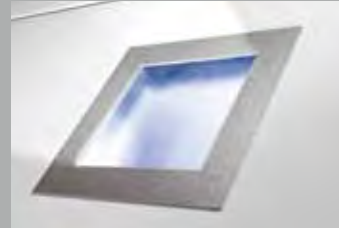

Design element with stainless steel and synthetic glazing

Special accent with inlays

M-ribbed, D-ribbed and T-ribbed doors are available in various inlay versions: e.g. continuous inlays run along the whole door width on style 501, while divided inlays, each 435 mm wide, are positioned on the left and right edges of the door on style 500.

The inlays are available in stainless steel or timber look as well as RAL to choose.



T-ribbed with inlays in stainless steel look

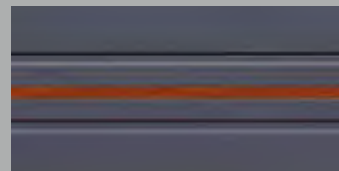

T-ribbed with inlays in timber look

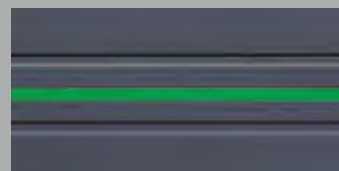

T-ribbed with inlays in RAL to choose (Fig. shows inlay in RAL 6018)

LTH 42

Solid timber doors are excellently suited for timber houses or buildings with many timber elements, such as timber framing or facade elements.

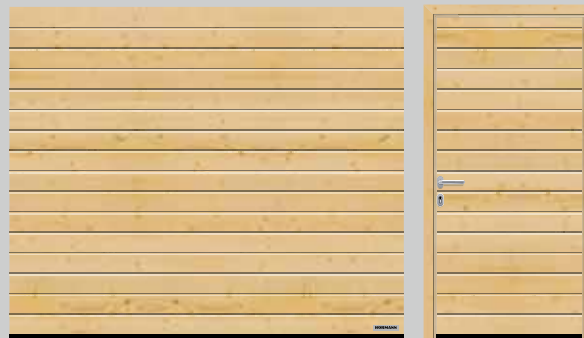

S-ribbed, Nordic Pine

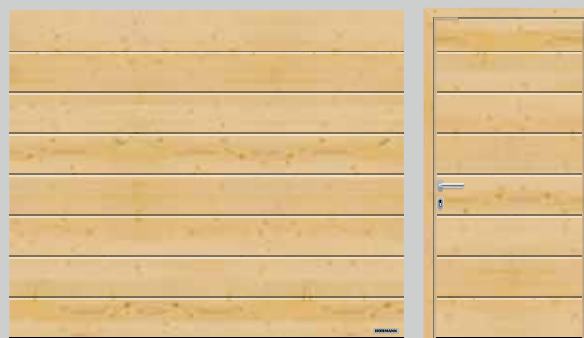

M-ribbed, Nordic Pine

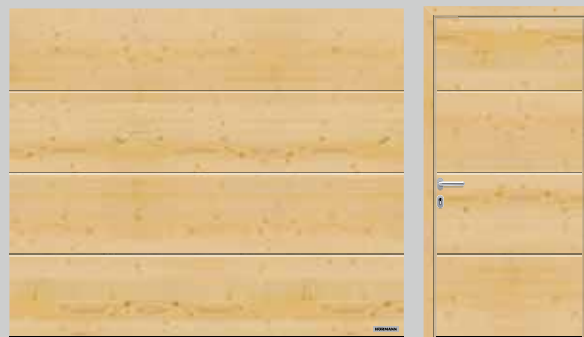

L-ribbed, Nordic Pine



Panelled, Nordic Pine



Style 401, Nordic Pine

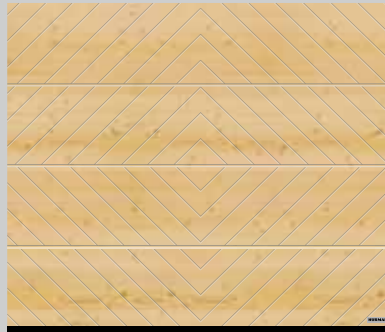

Style 402, Nordic Pine

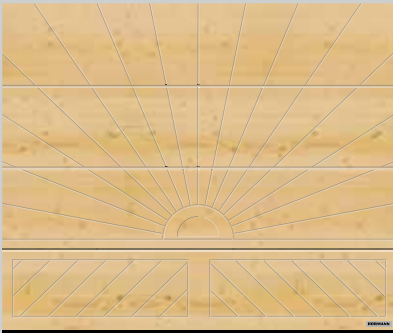

Style 403, Nordic Pine

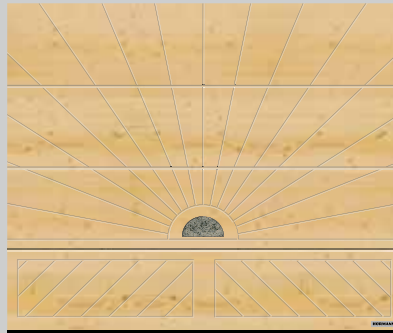

Style 403 with natural stone, Nordic Pine



Style 404, Nordic Pine



Style 404 with natural stone, Nordic Pine

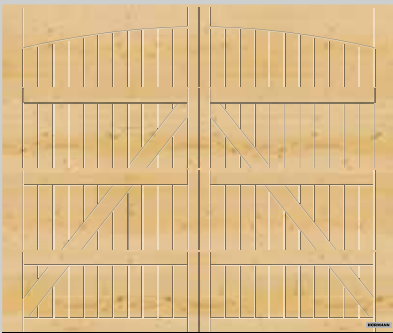

Style 405, Nordic Pine

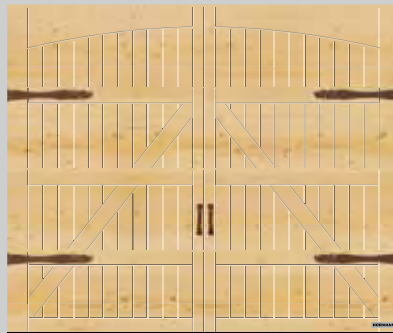

Style 405, with optional hinged door fittings "Exclusive", Nordic Pine



Individual designs

Design your own timber door: A simple drawing is enough for us to manufacture an individual door for you using a computer-aided mill.

Setting accents

Choose from 3 natural stones. In styles 403 and 404, natural stone is used as an attractive design feature. Variations in colour and structure are a natural characteristic.



Tropical-green



Multicolour-red



Balmoral-rosso

It's your choice

Design your garage door to exactly fit your needs. For steel sectional doors you can choose from up to 4 surface finishes that you can adapt to match the colour of your home. Or choose one of 6 Decograin decors with a natural timber look or a decor with an elegant metallic effect.

Solid timber sectional doors come in two types of timber that can be individually painted with one of 8 coloured varnishes.

Steel surface finishes

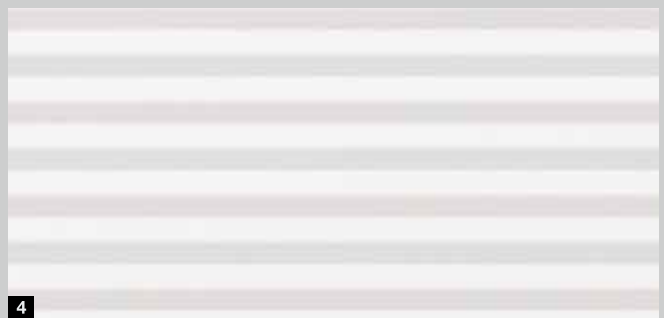
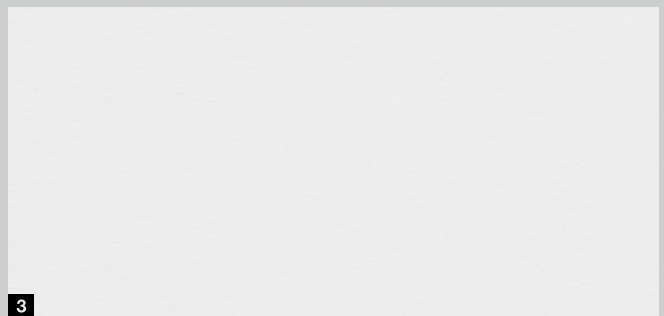
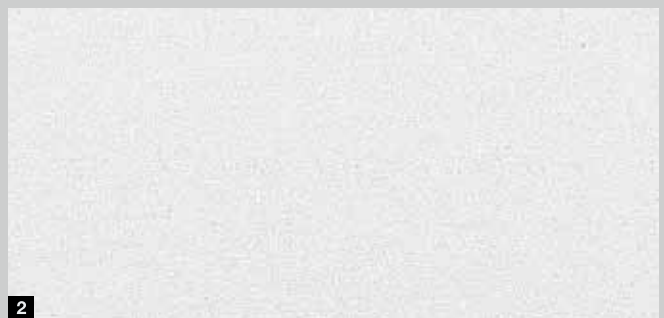

Types of timber



1 Woodgrain

On this inexpensive, robust surface with an authentic sawn timber look, minor scratches can be easily repaired by working with the texture. This surface finish is available in Traffic white RAL 9016, in 15 preferred colours or in RAL to choose.

2 Sandgrain

The finely structured surface is an ideal choice for price-conscious owners and is particularly suited for modern homes. Available in Traffic white RAL 9016 and in 3 preferred colours.

3 Silkgrain

Thanks to its elegant door appearance, the silky smooth Silkgrain surface finish is the first choice for modern architecture. A 50 % thicker exterior sheet on the sections also ensures higher stability and even smoother running. This surface finish is available in Traffic white RAL 9016, in 15 preferred colours or in RAL to choose.

4 Micrograin

This surface features a wave profile that is embossed into smooth steel, producing attractive light and shadow effects. It is available in RAL 9016, in 15 preferred colours or in RAL to choose.

5 Decograin

Decograin surface finishes with UV-resistant plastic film coating give your sectional door a striking and authentic timber look or an elegant metallic appearance in Anthracite. You can select from 5 natural timber decors or an elegant metallic decor.

6 Nordic Pine

Nordic Pine is a light-coloured softwood with predominantly straight graining. Heart shakes, individual resin pockets, spiral graining and the yellowish brown “knots” are natural characteristics of the wood.

7 Hemlock

Hemlock is a greyish white to light-greyish brown softwood with predominantly straight grain, brown mineral stripes along the grain with bark pockets.

GENERAL OVERVIEW

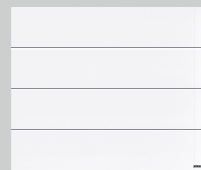
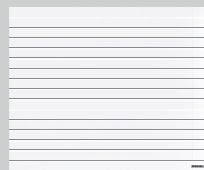

S-ribbed

M-ribbed

L-ribbed

LPU 67 Thermo Double-skinned steel sectional doors

	S-ribbed	M-ribbed	L-ribbed
Silkgrain		Traffic white RAL 9016 15 preferred colours RAL to choose	Traffic white RAL 9016 15 preferred colours RAL to choose
Decograin		3 decors: Golden Oak, Dark Oak, Titan Metallic CH 703	3 decors: Golden Oak, Dark Oak, Titan Metallic CH 703
Max. width		5000 mm	5000 mm
Max. height		3000 mm	3000 mm

LPU 42 Double-skinned steel sectional doors

	S-ribbed	M-ribbed	L-ribbed
Woodgrain	Traffic white RAL 9016 15 preferred colours RAL to choose	Traffic white RAL 9016 15 preferred colours RAL to choose	Traffic white RAL 9016 15 preferred colours RAL to choose
Sandgrain		Traffic white RAL 9016 3 preferred colours	Traffic white RAL 9016 3 preferred colours
Micrograin			Traffic white RAL 9016 15 preferred colours RAL to choose
Silkgrain		Traffic white RAL 9016 15 preferred colours RAL to choose	Traffic white RAL 9016 15 preferred colours RAL to choose
Decograin		6 decors: Golden Oak, Dark Oak, Night Oak, Rosewood, Winchester Oak, Titan Metallic CH 703	6 decors: Golden Oak, Dark Oak, Night Oak, Rosewood, Winchester Oak, Titan Metallic CH 703
Max. width	6000 (7000*) mm	6000 (7000*) mm	6000 (7000*) mm
Max. height	3000 (5000*) mm	3000 (5000*) mm	3000 (5000*) mm

LTE 42 Single-skinned steel sectional doors

	S-ribbed	M-ribbed	L-ribbed
Woodgrain	Traffic white RAL 9016	Traffic white RAL 9016	
Max. width	5000 mm	3000 mm	
Max. height	3000 mm	3000 mm	

* As sectional door SPU F42 Plus (for further information, see pages 84 / 85)

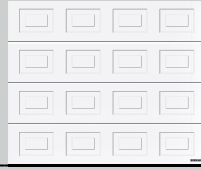
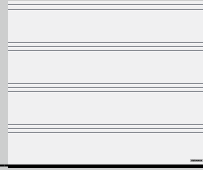
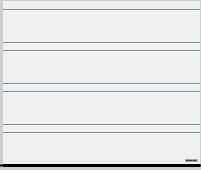

D-ribbed

T-ribbed

Panel

		Traffic white RAL 9016 15 preferred colours RAL to choose
Traffic white RAL 9016 15 preferred colours RAL to choose	Traffic white RAL 9016 15 preferred colours RAL to choose	
		5 decors: Golden Oak, Dark Oak, Night Oak, Rosewood, Winchester Oak
6000 mm 3000 mm	6000 mm 3000 mm	5500 mm 3000 mm
		Traffic white RAL 9016
		3000 mm 3000 mm

Please note:

Detailed size ranges can be found on page 88.

GENERAL OVERVIEW

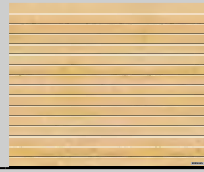

S-ribbed



M-ribbed

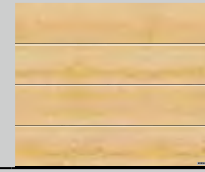

L-ribbed

LTH Solid timber sectional doors

Nordic Pine	8 types of wood preservative	8 types of wood preservative	8 types of wood preservative
Hemlock	8 types of wood preservative	8 types of wood preservative	8 types of wood preservative
Max. width	5000 mm	5000 mm	5000 mm
Max. height	3000 mm	3000 mm	3000 mm

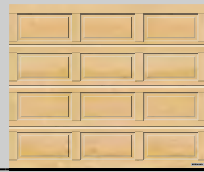

Panel

LTH Solid timber sectional doors

Nordic Pine	8 types of wood preservative		
Hemlock	8 types of wood preservative		
Max. width	5000 mm		
Max. height	3000 mm		

Please note:

Detailed size ranges can be found on page 88.



How to keep your home safe

Ensuring a safe environment for children

When garage doors become old, most people initially think of the outdated appearance. Many are not aware that the worn parts or an incorrect fitting can result in dangers that can lead to serious accidents. Building owners and redevelopers should therefore always pay attention to a **stop-reversing mechanism** on automatically operated garage doors. This ensures that the door stops as soon as it hits an obstacle. **This primarily protects children at play and pets;** the stop function prevents them from getting caught by the door.

Fire-rated doors ensure safety in the event of fire

Fire-rated doors can save lives in the event of a fire because they ensure that the fire does not cross over to adjacent rooms and, in the worst case, block escape routes. **Fire-rated doors are even stipulated by law** in areas at particular risk, **such as the transition point from the garage into the living space.** The apartment entrance doors developed for this use are not only fire-retarding, but also come with acoustic rating and with break-in-resistant RC 2 equipment as standard. This door can be optionally supplied as a smoke-tight version.



Our own four walls are the place where we feel at home, they are our retreat and give us a sense of security. For most people, safety means thinking about burglar-proof aspects. However, a safe home not only involves the best protection against intruders, but also the safest possible environment for playing children and safety in the event of a fire. In this advice section, we will inform you about the most important aspects of a secure home, which you should consider when building or modernising your home.

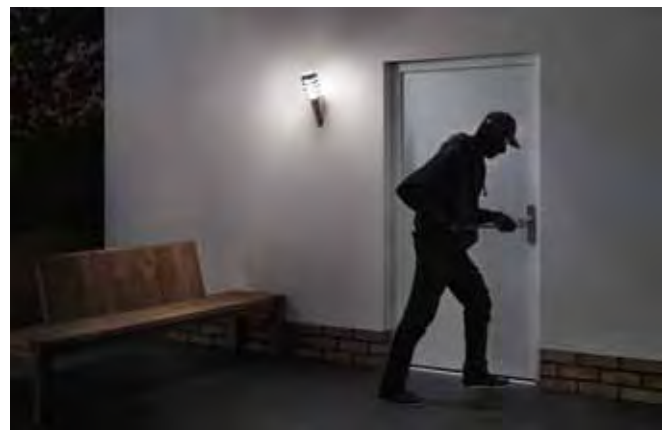

Protecting against break-ins and deterring intruders

If you are looking for the best protection against break-ins, you should select a high resistance class when choosing doors; whether it's an entrance door, side entrance or cellar door. The higher the specified class, the more time and effort an intruder needs to gain access to the house.

Because **cellar and side doors are still the most popular ways into the house or garage for intruders**, this is exactly where you should use break-in-resistant RC 2 side doors. **For entrances, we recommend high-quality aluminium entrance doors with RC 3 security equipment as standard.**

Garage doors can also pose a security risk if they can be easily forced open. Unlike doors from other manufacturers, Hörmann automatic garage doors have a special anti-lift kit, which even prevents the door from being forced open in case of a power failure.



▲ S-ribbed in Woodgrain Anthracite grey RAL 7016; Hörmann aluminium entrance door ThermoSafe, style 650 Anthracite grey RAL 7016



▼ S-ribbed in Woodgrain in Traffic white RAL 9016 with matching side door



▲ S-ribbed with solid timber panels in Hemlock with matching side door

M-RIBBED



► M-ribbed in Silkgrain Traffic white RAL 9016 with LED light strip on lintel and light key switch posts SLS





▲ M-ribbed in Silkgrain Anthracite grey RAL 7016; Hörmann aluminium entrance door ThermoSafe, style 861 Anthracite grey RAL 7016

◀ M-ribbed in Decograin Titan Metallic CH 703 as industrial sectional door SPU F42 Plus for garages up to 7000 mm wide (for further information, see pages 84 / 85)



▲ L-ribbed in Decograin Titan Metallic CH 703

► L-ribbed in Decograin Titan Metallic CH 703 as industrial sectional door SPU F42 Plus for garages up to 7000 mm wide (for further information, see pages 84 / 85)





▼ L-ribbed design style 457 in Silkgrain Traffic white RAL 9016;
Hörmann aluminium entrance door ThermoSafe style 188



► T-ribbed in Silkgrain Anthracite grey RAL 7016 style 501 with continuous inlays in stainless steel look

▼ D-ribbed in Silkgrain Anthracite grey RAL 7016; Hörmann aluminium entrance door ThermoCarbon, style 304 Anthracite grey RAL 7016





▲ T-ribbed style 501 in Silkgrain Stone grey RAL 7030 with continuous inlays in timber look

PANEL



▲ Panelled with solid timber panels in Hemlock with wood preservative in Limestone white

▶ Panelled in Decograin Golden Oak





◀ Panel in Woodgrain Traffic white RAL 9016;
Hörmann aluminium entrance door ThermoSafe
style 449 in Traffic white RAL 9016



ALR F42 FOR EXCLUSIVE DOOR AESTHETICS

Exclusive facade designs

With on-site, flush-fitting facade cladding, you can design your sectional door according to your wishes with timber, metal, ceramic, plastic and many other materials. This way your garage door is seamlessly integrated into the overall design of your home.

The door basis for facade cladding is a Hörmann industrial sectional door ALR F42 with an aluminium frame construction and PU sandwich infill. Please consult with your local Hörmann specialised dealer.



► Sectional door ALR F42 with on-site cladding

▼ Sectional door ALR F42 with on-site cladding





◀ Sectional door ALR F42 Vitraplan

ALR F42 Vitraplan

The door is especially elegant thanks to offset, flush-fitting glazing. The frame profile is concealed, so nothing detracts from the overall appearance. This exclusive door fascinates with a mix of mirroring and transparency.

DESIGN SOLID TIMBER DOORS

► Door style 405, painted white on-site with hinged door fitting kit and decorative handles

▼ Door style 403 in Nordic Pine with tropical green natural stone



◀ Door style 402 in Nordic Pine with a matching side door



Individual designs

Design your timber door to, for example, display your initials, house number or your favourite motif. Just provide us with an appropriate drawing and we will create a personal garage door for you. It will be an enviable original.

A bright variety

No matter the architectural style, with Hörmann, you are guaranteed to find a sectional garage door to fit your personal style and home. For steel sectional doors, you can choose from 15 equally-priced preferred colours, approx. 200 RAL colours and 6 Decograin decors. The door surfaces are optimally protected against rust allowing you to enjoy your new door for a long time. Rain runs off without leaving any streaky marks thanks to the use of hot-galvanized material and a high-quality polyester-primer coating on both sides. Solid timber doors are available in two types of timber, each of which can be glazed in one of 8 colours to match your home.





Beautiful and protective colour

Double-skinned LPU sectional doors and side doors are available as standard in Traffic white, RAL 9016, as well as in 15 inexpensive preferred colours and in around 200 colours from the RAL colour chart*, as well as in many NCS and DB colours. You can choose from 3 preferred colours** for the surface finish Sandgrain. Single-skinned LTE 42 doors are only available in Traffic white.

Standard colour



1

15 preferred colours



2



3



4



5



6



7

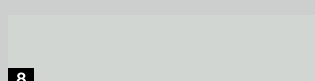

8



9



10



11



12



13

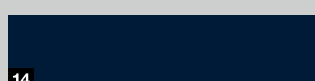

14



15

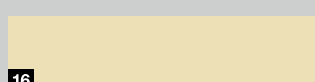

16

- 1 RAL 9016 Traffic white
- 2 RAL 9007 Grey aluminium
- 3 RAL 9006 White aluminium**
- 4 RAL 8028 Terra brown**
- 5 RAL 8003 Clay brown
- 6 RAL 8001 Ochre brown
- 7 RAL 7040 Window grey
- 8 RAL 7035 Light grey
- 9 RAL 7030 Stone grey
- 10 RAL 7016 Anthracite grey**
- 11 RAL 6009 Fir green
- 12 RAL 6005 Moss green
- 13 RAL 5014 Pigeon blue
- 14 RAL 5011 Steel blue
- 15 RAL 3003 Ruby red
- 16 RAL 1015 Light ivory

Please note:

Sectional garage doors are generally supplied in Grey white, RAL 9002 on the inside of the door.

Dark colours should not be used for double-skinned steel doors that are exposed to the sun, as possible section deflection may damage the door.

All colours based on RAL.

The colours and surfaces shown are subject to the limitations of the printing process and cannot be regarded as binding. Please consult with your local Hörmann specialised dealer.

* RAL Classic colours, with the exception of pearl-effect, fluorescent and metallic colours

** Preferred colours for Sandgrain surface finish

Elegance and detailed accuracy

Decograin is available in five natural-looking timber designs and with an anthracite metallic effect. An embossed wood grain gives it an authentic timber character. The door remains beautiful for a long time thanks to the special surface protection of the UV-resistant plastic film coating on the outside of the steel sections.

6 Decograin decors

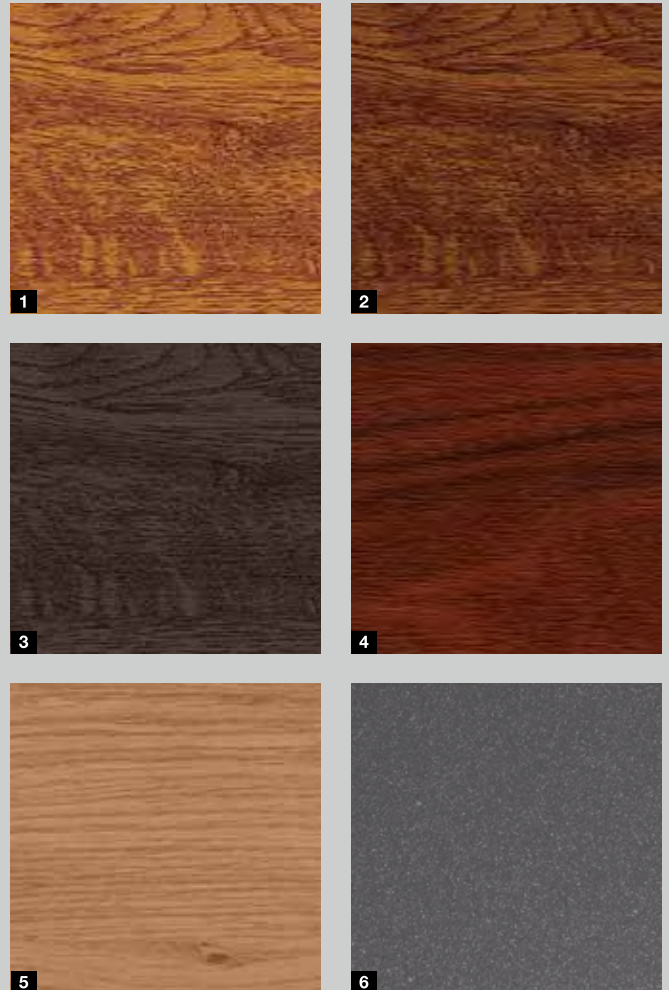

- 1 Decograin Golden Oak: medium brown, golden yellow oak decor
- 2 Decograin Dark Oak: walnut-coloured oak decor
- 3 Decograin Night Oak: dark, intense oak design*
- 4 Decograin Rosewood: mahogany-coloured timber design*
- 5 Decograin Winchester Oak: natural-coloured knotty oak design*
- 6 Titan Metallic CH 703: Anthracite with a metallic effect

* Not for LPU 67 Thermo

Natural types of solid timber

Nordic Pine is a light-coloured softwood with predominantly straight graining. Heart shakes, individual resin pockets, spiral graining and the yellowish brown “knots” are natural characteristics of the wood.

Hemlock is a greyish white to light-greyish brown softwood with predominantly straight grain, brown mineral stripes along the grain with bark pockets.

Please note:

The timber is impregnated at the factory to protect it against insect and fungal attack. To protect it from weathering and retain its beautiful appearance, please treat the timber with a wood preservative.

With wood preservatives, the wood content may show through the coating, leading to a change in the surface colour.





2 types of solid timber



1



2

8 types of wood preservative

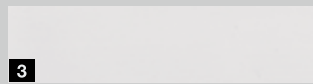

3



4



5



6



7



8



9



10

- 1 Nordic Pine, impregnated
- 2 Hemlock, impregnated
- 3 Limestone white, painted or opaque
- 4 Pine
- 5 Teak
- 6 Rosewood
- 7 Ebony
- 8 Agate grey
- 9 Fir green
- 10 Nordic red

Aesthetic, understated, secure

If your garage does not have a second entrance, you can optionally open your automatic garage door LPU 42, LTE 42 and LTH 42 from the outside with a beautifully designed handle or an understated emergency release lock.



Please note:

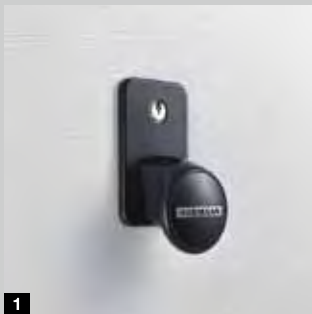

1



2

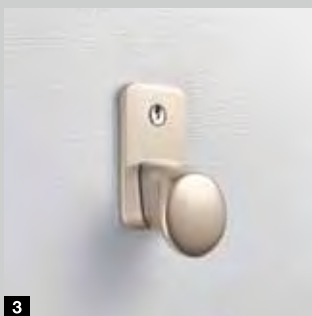

3

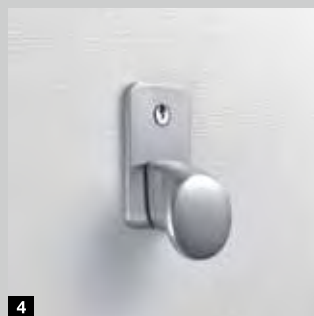

4



5



6



7

Door handles

Hörmann door handles are set apart by a contemporary, modern shape. Here, the selection of material is not just a question of personal taste. For example, stainless steel handles are particularly robust and have a tough surface finish.

The lock can be integrated in the home locking system. Manually operated doors with a handle are locked and break-in-resistant with a latch lock **7**. In this lock, a sturdy, automatic latching disc engages around a massive bolt on the side frame.

Emergency release

If you do not want a handle on your automatic sectional door, we recommend using an emergency release lock **6** on garages without a second entrance. An inconspicuous round cylinder (cannot be integrated in the home locking system) releases your garage door and you can easily open it in the case of an emergency.

For automatic sectional doors with a handle, you can use a lever handle to operate the emergency release. The door is then unlocked via a Bowden cable on the inside.

For sectional doors LPU 42, LTE 42 and LTH 42

- 1 Black plastic
- 2 White cast aluminium, RAL 9016
- 3 Silver cast aluminium
- 4 Brushed stainless steel
- 5 Brown cast aluminium, RAL 8028
- 6 Emergency release lock
- 7 Latch lock

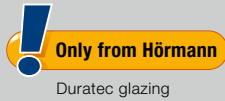

More light, less energy consumption

Depending on the door type, you can select from various types of glazings with clear (Fig. right) or textured panes.

Clear synthetic glazing from Hörmann comes as standard with DURATEC glazing.

It offers:

- Maximum scratch resistance
- A permanently clear view
- Improved thermal insulation



Please note:

Glazing is also possible in the two bottom door sections after technical inspection.

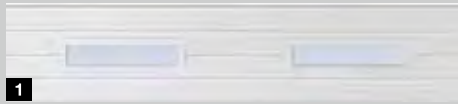

1



2

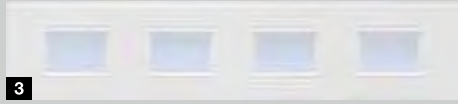

3



4

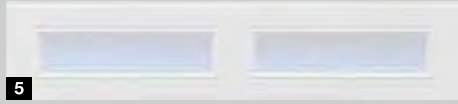

5



6



7



8



9



10

- 1 Glazing type D*
- 2 Aluminium frames**
- 3 Classic glazing S0*
- 4 Classic glazing M0*
- 5 Classic glazing L0*
- 6 Classic glazing S1
- 7 Classic glazing S2
- 8 Sunrise glazing S10
- 9 Sunrise glazing S60
- 10 V-panelled glazing V0

The glazings shown (1-8, 10) correspond to a door width of 2500 mm.

* Individual arrangement of glazings is possible

** Rails are possible

Your Hörmann partner would be pleased to advise you about the numerous glazing options.

The glazing frames are supplied in the colour to suit the decor with the Decograin surface finish.

	Glazing type D	Aluminium frame	Classic glazing	Sunrise glazing
Design				
S-ribbed	●	●		
M-ribbed	●	●	●	●
L-ribbed	●	●	●	●
D-ribbed	●	●		
T-ribbed	●	●		
Panel			●	●
Glazing frames				
Version	Plastic (in all colours, also different from door colour)	Aluminium (in all colours, also different from door colour)	Plastic (in all colours, also different from door colour)	Plastic (in all colours, also different from door colour)
Clear / textured glazing				
Single / double pane LPU 42, LTE 42	●	●	●	●
Triple pane LPU 67 Thermo	●	●	●	●

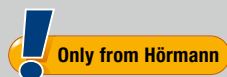

An easy passage into your garage

A door in the door lets you easily access whatever you have in your garage, such as gardening tools, bikes or wheelbarrows. Only Hörmann offers a wicket door with a stainless steel threshold that is only 10 mm in the centre and 5 mm high at the sides. This reduces the risk of tripping up and makes it easier to wheel things through. The aluminium door frame is anodised as standard in a natural finish and is also available in all colours. The top garage door section, also in the wicket door area, comes with a continuous lintel seal. Doors with wicket doors are available with a door width of up to 5 m ■ **NEW**.

Please note:

Wicket doors with trip-free threshold are only available for sectional door LPU 42.

On request, Decograin wicket doors can be supplied with the frame painted to match the colour of the decorative finish. The frame is available in all colours, also different from door colour.

In some cases, adjacent panelled doors with the same width, with and without a wicket door, may not have an identical panel division.

Manually-operated garage doors with a wicket door do not have an outside handle. They are locked from the inside.

The optional leading photocell VL 2 stops the door without contact. This further increases the safety of your garage door with wicket door and trip-free threshold.





1 Overhead door closers

As standard, wicket doors are supplied with slide rail door closers incl. integrated opening angle limit and hold-open device (top figure). An integrated door closer, including hold-open device (fig. on bottom) is optionally available for optimum protection and the best appearance.

2 Optional multiple-point locking

The wicket door is locked over the entire door height with one bolt and hook bolt per section. The advantage: better stability and improved break-in-resistance.

3 Robust door catch

This prevents door-leaf drop and buckling.

4 Concealed hinges

For a uniform look, the wicket doors are equipped with concealed hinges as standard.

A matching side door for every garage door

However large your side entrance might be and however high the demands are on thermal insulation: At Hörmann you are guaranteed to find the right side door for your garage.

Single-leaf doors for small, double-leaf doors for large entrances, each in versions NT60 and NT80. With aluminium profiles with thermal break, frame and threshold rail, the NT80 is the best choice for heated garages or garages with access to the house. On request, we can also supply side doors in the same ribbing or panel division as your sectional door so you can design a side entrance to match your garage door.





SIDE DOORS

Garage side doors NT60

The doors are supplied ready-to-fit with profile cylinder mortise lock, round handle / lever handle set with oval rose escutcheons and with 3-way adjustable hinges. Door leaf frames are made of weather-proof aluminium extrusions (depth 60 mm) with all-round seals. Double-leaf side doors are also available with asymmetrical division, i.e. with uneven door leaf widths.

Insulated version NT80

The garage side doors TopComfort NT80 impress with an aluminium profile system with thermal break, frame and threshold rail, as well as a depth of 80 mm.



Single-leaf NT60 with narrow leaf frame



Single-leaf NT60 with wide leaf frame



Garage side doors with thermal break TopComfort NT80



Double-leaf NT60 with wide leaf frame

Garage side door NT60	Single-leaf		Double-leaf
	Narrow	Wide	Wide
Leaf frames			
Aluminium block frame	●		●
Aluminium corner frame	●		-
Narrow leaf frame	●		-
Wide leaf frame	●		●
Thermal insulation	U = 2.7 W/(m ² ·K)		U = 2.9 W/(m ² ·K)



1

1 Lever handle set

Choose between the standard lever handle or many optional lever handle or lever / knob handle sets (Fig: stainless steel lever handle set). Your Hörmann partner would be pleased to advise you.



2

2 Fixed bolt

The fixed leaf on double-leaf side doors can be individually locked.



3

3 Matching

Decograin side doors come with identical surface finishing for the frame, subframe and door to create a matching appearance. The inside of the sections is Grey white, RAL 9002, as standard.

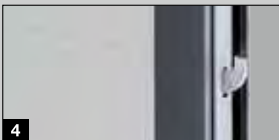
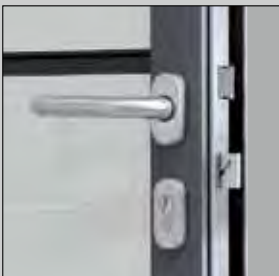
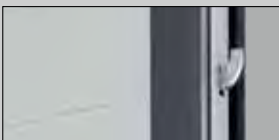

4

4 Break-in-resistant

You can also optionally equip side doors NT60 with RC 2 security equipment. The 3-point locking equipped with a latch, bolt, 2 locking hooks and security rose escutcheon is available for profile type 2.



MZ Thermo multi-purpose door

If you highly value good thermal insulation, an MZ Thermo external door with thermal break is the best choice for you. It has an excellent thermal insulation value of 1.2 W/(m²·K). An RC 2 version is optionally available (KSI Thermo).

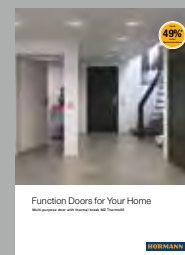

Additional information can be found in the Function Doors for Your Home brochure.

Out with the old, in with the new

At some point it is simply time to modernise your garage door. Hörmann can provide you with an attractive and appropriate solution for any fitting situation. Inexpensive standard sizes, especially created for modernisation, will save you money and get you using your new sectional door faster. Your Hörmann partner also provides you with a complete package of services:

- Qualified consultation
- Measurement on-site
- Professional fitting
- Removal and environmentally-friendly disposal



Your Hörmann partner would be pleased to advise you on-site.





HÖRMANN

Tore • Türen • Zargen • Antriebe



313 CDI

GT JA 19



Standard fitting **1**

Ideally, the available garage has at least 100 mm of clearance in the lintel area (at least 115 mm for doors with operators) and a 90 mm sideroom. The frame can then be screwed directly into the wall behind the opening.

Hörmann sectional doors come with all the necessary fitting materials for this situation.



Special anchor for frame side fixing

The sectional door frame can be fitted to the side wall of the garage with Hörmann's optional, universal anchors. Irregularities in the wall can be easily compensated, leaving the reveal intact.

2 Fitting with up to 35 mm wall spacing

3 Fitting with angled or irregular side wall

4 Fitting with non-load bearing facades (facing brick or thermal insulation) with at least 90 and max. 125 mm sideroom



Frame covering in the colour of the door

At Hörmann, side frames are delivered in Woodgrain white as standard. With a frame covering that matches the door sections' surface finish and colour or decor, you can also achieve a harmonious appearance for doors. For Micrograin doors, the frame covering comes with a smooth Silkgrain surface finish. Two different widths make it possible to cover the side frame for different fitting situations.

5 55-mm-wide frame covering for fitting behind the opening, with little sideroom (< 90 mm)

6 90-mm-wide frame covering for fitting in the opening, flush with the wall





Fascia panels **1** ■ NEW

For greater distances between the side wall or ceiling and the door frame, the gap is sealed with panels in the appearance of the door sections. This creates a harmonious overall impression because the door style continues over the frame. Fascia panels are available for all door styles and also with design elements.



Fascia frame set 95 for lintel and side wall

A door in an inexpensive standard or modernisation size can be fitted in the opening. The remaining gap between the side wall or lintel and door frame (max. 35 mm) is covered using a fascia frame set **2**. This set comes with fascia panels in the surface finish and colour or design of the door sections, end caps and fixing materials. For Micrograin doors, the frame covering comes with a smooth Silkgrain surface finish. The fascia panels **3** match the surface finish and colour or decor of the door as standard. Additionally, the side frame is covered with a frame covering **4** in the surface finish and colour or decor of the door sections.

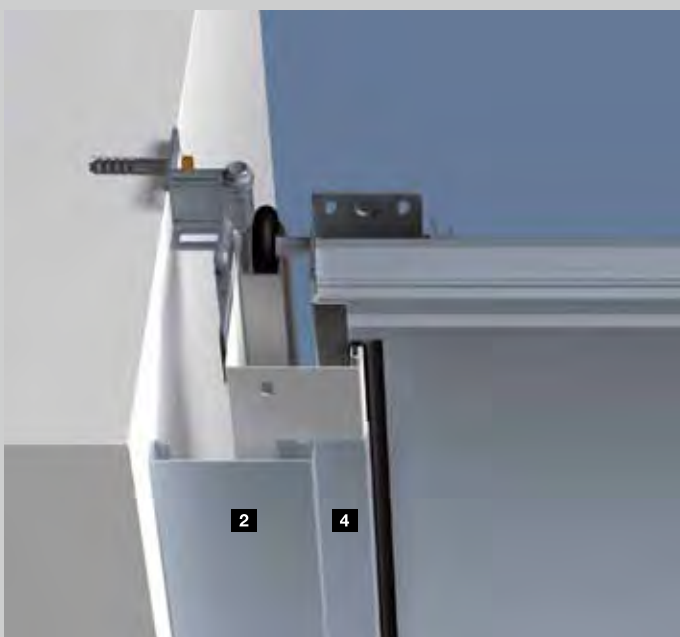



Fascia panels for standard fitting behind the opening with small lintel space **1**

For all door versions, our standard fascia panels always match the door surface finish and colour or style and can thus be visibly mounted in the opening.



Double-skinned fascia panel for fitting in the opening with larger gap to the ceiling **2**

A matching, double-skinned additional fascia panel covers the gap between the ceiling and fascia panel. It is available for all surface finishes and colours or designs. Glazings are also possible after technical inspection.

This panel can be optionally supplied as an aluminium frame.



Flush-fitting fascia panels **3**

For LPU 42 doors, a fascia panel is the most elegant solution for an invisible transition between the panel and door leaf. When the door is closed, the top door section is flush with the panel. It is available for all door styles with all surface finishes and colours or designs (panelled on request).



Retrofit fascia set to properly cover damaged wall edges **1**

Unattractive gaps in the lintel and opening areas can be covered easily with the optional retrofit fascia, doing away with the need for additional brick laying and plastering work. The set with 3 fascia panels (each 3 metres long) is available in all surface finishes and colours or decors to match the door. Micrograin doors are supplied with retrofit fascias in a smooth Silkgrain version.



Recess set **2**

When removing an old up-and-over door and fitting a new LPU 42 sectional door, a time-consuming process is often necessary to remove the threshold rail or straighten the ground. With the recess set, these steps can be omitted as the sectional door is positioned in front of the threshold rail. The set consists of a compensation profile **3** and special track applications. The frame must be shortened by 25 mm if the set is used. This can either be ordered in the desired dimensions or shortened on-site.



Storm shield **4** ■ NEW

The profile is simply fitted to the floor and seals off the door bottom edge additionally. It prevents the penetration of water across the full door width. The low height ensures barrier-free access.

For further information, please see the fitting data or contact your Hörmann partner.

Reliable, safe and maintenance-free

Hörmann garage door operators are perfectly matched to your Hörmann sectional door. The result: simple operation, maximum convenience and the greatest operational safety. On encountering an unexpected obstruction, the automatic safety cut-out stops the door safely and reliably. Your door opens and closes quietly and smoothly with the soft start and soft stop. Our elegant hand transmitters allow you to open your gate from your car as easily as you would operate a TV. You can also operate your door using stationary control elements, such as a radio code switch or radio finger-scan.



Garage Door and Entrance Gate Operators



More information can be found in the Garage Door and Entrance Gate Operators brochure.







SupraMatic – the supra-fast operator with many additional functions

- As standard with 5-button hand transmitter HS 5 BS and 4-button hand transmitter HSE 4 BS
- Querying of the door position
- Low power consumption
- Easy to program
- 2x 7-segment display
- Separately switchable LED lighting with energy efficiency class A++
- Adjustable ventilation slot
- Automatic door locking
- Operator cover made of brushed aluminium



HS 5 BS black textured surface with chrome caps



HSE 4 BS textured black with plastic caps

Garage door operators	SupraMatic E	SupraMatic P
Special feature		For timber doors and doors with wicket doors
Equipment		Photocell
Cycles per day / hour	25 / 10	50 / 10
Pull and push force	650 N	750 N
Peak force	800 N	1000 N
Max. opening speed	22 cm/s	22 cm/s
Max. door width	5500 mm	6000 mm
Max. door surface	13.75 m ²	15 m ²



ProMatic – the good-value starter model as an introduction to Hörmann’s premium quality

- As standard with two 4-button hand transmitters HSE 4 BS
- Adjustable ventilation slot
- Automatic door locking
- LED lighting with energy efficiency class A++



ProMatic Akku for garages without a power connection

- Standard hand transmitter and functions as with the ProMatic
- Optional solar module to recharge the battery



HSE 4 BS textured black with plastic caps



ProMatic Akku with solar module

Garage door operators	ProMatic**	ProMatic Akku**
Special feature		For garages without power connection
Cycles per day / hour	12 / 5	5 / 2
Pull and push force	600 N	350 N
Peak force	750 N	400 N
Max. opening speed	14 cm/s	13 cm/s
Max. door width	5000 mm	3000 mm
Max. door surface	11.25 m ²	8 m ²

* The complete warranty conditions can be found at: www.hormann.co.uk

** Not for LPU 67 Thermo



Hand transmitter HS 5 BS

4 button functions plus query button

1 High-gloss surface black or white

2 Textured surface black



Hand transmitter HS 4 BS

4 button functions

3 Textured surface black

Hand transmitter HS 1 BS

1 button function

4 Textured surface black

Hand transmitter HSE 1 BS

1 button function, incl. eyelet for key ring

5 Textured surface black



Hand transmitter HSE 4 BS

4 button functions, including eyelet for key ring

6 Textured surface black with chrome or plastic caps

Hand transmitter HSE 2 BS

2 button functions, including eyelet for key ring

7 High-gloss surface black or white

8 High-gloss surface green, purple, yellow, red, orange

9 Decors in silver, carbon, dark rootwood

(Shown from left to right)





**10 Hand transmitter
HSD 2-A BS**

Aluminium look, 2 button functions, can also be used as a key ring

**11 Hand transmitter
HSD 2-C BS**

High-gloss chrome, 2 button functions, can also be used as a key ring



12 Hand transmitter HSP 4 BS

4 button functions, with button lock-out, including key ring

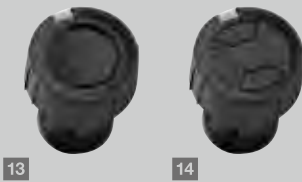

13 Hand transmitter HSZ 1 BS

1 button function, for insertion in vehicle cigarette lighter

14 Hand transmitter HSZ 2 BS

2 button functions, for insertion in vehicle cigarette lighter



Hand transmitter

Hörmann offers numerous beautifully shaped models that can be assigned up to 5 functions. All control elements use our innovative BiSecur radio technology.



HSZ hand transmitter

The alternative to homelink systems: integrated in an inconspicuous spot in your car. Inserted in the vehicle's cigarette lighter, the HSZ hand transmitter is easily accessible and convenient to operate.



**Radio code switch
FCT 3 BS**

For 3 functions, with illuminated buttons



**Radio internal push button
FIT 2-1 BS**

For 2 functions, connection option for maximum 2 control elements via cable, e.g. key switches



**Radio code switch
FCT 10 BS**

For 10 functions, with illuminated buttons and protective cover



**Radio internal push button
FIT 1 BS**

1 button function with large button for simple operation



**Radio internal push button
FIT 4 BS**

4 button functions



**Radio finger-scan
FFL 12 BS**

For 2 functions and up to 12 fingerprints



**Radio internal push button
FIT 5 BS**

4 button functions plus query button



Recessed radio transmitter

For recessed buttons with up to two functions, central installation in the house within sight of the garage door

HSU 2 BS: for switch boxes with 55 mm Ø with connection to the house mains supply

FUS 2 BS: for switch boxes with 55 mm Ø, including 1.5 V battery



**Radio receiver electric socket
FES 1 BS**

For switching lights and other devices on and off up to 2500 watts

FES 1-1 BS

For controlling (impulse) operators of other makes and switching lights and other devices on and off up to 2500 watts



Key switch 1 STUP 50
2 STAP 50

In a recessed version and surface-mounted version, including 3 keys



Internal push button IT 1b-1
 Large, illuminated button for convenient opening of the door



Transponder key switch TTR 1000-1

For 1 function, for 1000 teachable keys, 1 key in scope of delivery (more on request)



Internal push button IT 3b-1

Large button with illuminated ring for opening of the door, buttons for the operator light and to switch off the radio control (only for SupraMatic)



Code switch CTP 3-1

For 3 functions, with illuminated lettering and touch-sensitive black touch surface



Photocell EL 101

One-way photocell system, immediately stops the door when the light beam is interrupted



Code switch CTR 1b-1 / 3b-1

For 1 or 3 functions



Emergency battery HNA for garage door operators

Emergency power supply to bypass power failures up to 18 hours and max. 5 door cycles, recharges during normal operation, for all current Hörmann garage door operators



Code switch CTV 3-1

For 3 functions, particularly robust with metal keypad

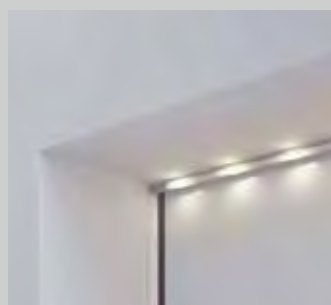

LED light strip

Neutral white light, variable plug-in system, can be fitted to lintel or bottom edge of door leaf, LED spacing: 125 mm, energy efficiency class A

Optimum ventilation of the garage can effectively prevent mould

It is very important to ventilate the garage regularly; especially if insulated garage doors are fitted in poorly insulated garages. Ventilation is achieved by folding down the top section (optional equipment) top prevent dirt, leaves or small animals from entering the garage. An additional climate sensor, which automatically regulates ventilation, is recommended for energy-efficient ventilation.





1

1 Ventilation slot on the topmost section

The optional folding roller bracket means that you only open the top section of your door to ventilate the garage. The bottom door section remains sealed on the ground, thus offering protection against small animals or leaves. The ventilation slot is operated using the “2nd opening height” operator function on doors with operator*.

The folding roller bracket is optionally available on all sectional garage doors LPU 67 Thermo* and LPU 42* with operator and can be retrofitted on all sectional garage doors LPU 42* with operator SupraMatic** or ProMatic**.



2

2 Inside climate sensor HKSI for automatic garage ventilation

The inside climate sensor for operators SupraMatic 3 (from Index C) and WA 300 S4 (from Index D)*** monitors humidity in the garage and regulates the ventilation. If humidity is too high, the door is automatically opened using the “2nd opening height” operator function and then automatically closed again once humidity is adjusted.

For optimum operation, the temperature range in which the door does not open (e.g. if there is a risk of frost in the garage), the operating times (e.g. overnight shut-off) and the opening times (e.g. max. 2 hours per ventilation) can be adjusted.

The optional exterior sensor HKSA additionally measures the humidity outside and prevents the door from opening in case of high humidity levels. An on-site fan can also be installed for fast and effective ventilation.



3

* Only track application N, L, Z

** From year of manufacture 2012

*** A photocell is required on doors without ventilation slot if the door closing edge is 30 mm or more above the floor in the ventilation position.

Operating comfort with the highest security



Safety while operating the garage door is top priority for Hörmann. And Hörmann sets the standards for this with its innovative solutions. This has been proven time and time again through numerous Hörmann patents. Hörmann sectional doors are tested and certified in accordance with the high safety requirements of European standard 13241-1, not only on their own but also in combination with operators. It would be hard to find a safer sectional door.

This provides you and your family with safety during daily use.

It pays to compare!





1

Hörmann patent

1 Tension spring assembly with spring-in-spring system

Double tension springs and double cabling on each side safeguard the door leaf against crashing to the floor. Thanks to the patented spring-in-spring system, broken springs are prevented from flying out and causing injuries. Sectional doors up to 3000 mm wide and 2625 mm high include the proven tension spring technology as standard.



2

Hörmann patent

2 Torsion spring assembly with integrated spring safety device

Torsion springs on both sides feature a patented spring safety device. In the event of a spring breaking, they arrest the door immediately, thereby preventing the door leaf from crashing to the floor. Larger sectional doors and doors with integral wicket door or garage doors with solid timber panels feature torsion spring technology.



3

Hörmann patent

3 Secure guidance of the door in safety tracks

Patented, adjustable track rollers, sturdy roller holders and safety tracks ensure that there is no danger of the door "derailing". The door sections are safely parked under the ceiling.



4

4 Finger trap protection on the inside, outside and on the hinges

The unique form of the door sections eliminates trap points, both between the sections and on the hinges.



5

5 Trap guard on the side frame

With Hörmann, the frames are completely closed from top to bottom. There are no gaps between the door leaf and frame in which fingers could get trapped!

The premium and energy-saving door

LPU 67 Thermo is the best choice for you, if your garage is directly attached to the house or if you use the room as a workshop or hobby room. Thanks to excellent thermal insulation and the harmonious inside view in the premium version, it meets all the needs of a multi-purpose room you can feel comfortable in.



Standard version
Galvanized fittings, frame, tracks and connection rails



Premium version
Fittings, frames, tracks and connection rails in Grey white RAL 9002 (matching the inside of sections) as well as tandem track rollers for very quiet and gentle door travel

* Galvanized spring assembly incl. holder, spring safety device, cable drum, operator boom

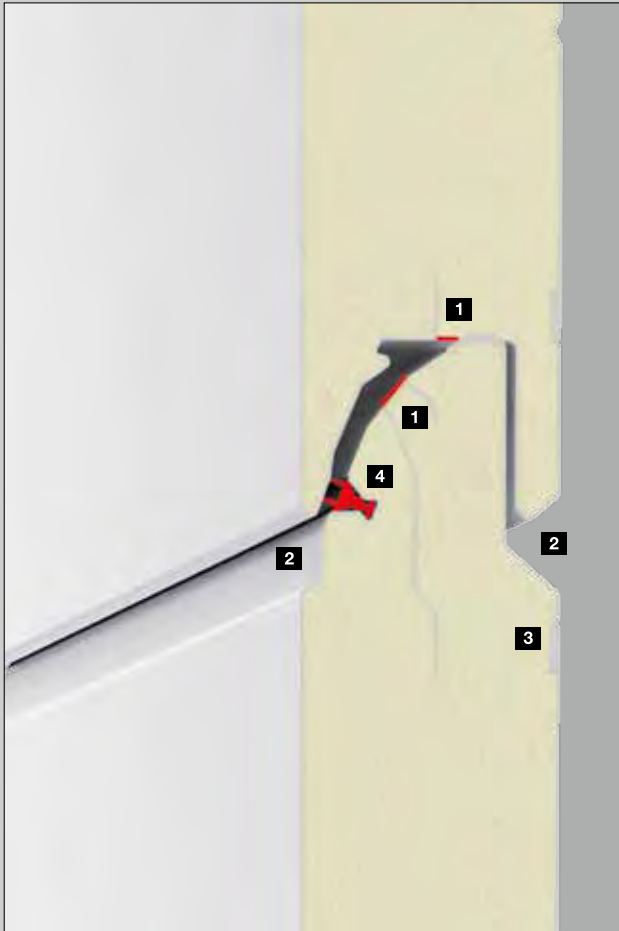

Standard version with excellent thermal insulation

- U-value of sections: 0.33 W/(m²·K)
- U-value of door*: 1.0 W/(m²·K)
- Up to 30 % better thermal insulation compared to a sectional garage door LPU 42

- 1 67-mm-thick sections with thermal break
- 2 Finger trap protection outside and inside
- 3 Triple sheet steel reinforcement in screw fixing area
- 4 Double lip seal in the section transitions
- 5 Double bottom seal

Further equipment options:

- All glazing types available for depth 42 mm
- Aluminium glazing frame with thermal break
- All glazings with triple panes
- Optional ThermoFrame for up to 10 % better thermal insulation (U-value of the door*: 0.9 W/(m²·K)), for further information, see pages 86 – 87.

Energy modernisation of existing doors

If you would like improved thermal insulation for your fitted LPU 42 door (from BR 40), the 42-mm-thick sections can be retrofitted (replaced) with 67-mm-thick sections with thermal break. The frame does not need to be replaced.

* Door size 5000 × 2125 mm



5

For door openings up to 7000 mm wide and special fitting situations

The industrial sectional door SPU F42 Plus is the ideal solution for especially wide garages and for fitting situations where an operator cannot be fitted above the door. It is available for S-, M- and L-ribbed door styles with all surface finishes, decors and colours. For specific fitting dimensions, please see the technical manual for industrial sectional doors.





1

1 Operator SupraMatic HT

For garage doors over 6000 mm wide, the **SupraMatic HT operator is the first choice**. The rail-guided operator features the same equipment* and functions as the SupraMatic E, such as soft start and soft stop, adjustable ventilation slot and automatic door locking.



2

2 Shaft operator WA 300 S4

If it is not possible to install the operator in the garage in the centre with a guide rail, we recommend the **shaft operator WA 300 S4 for side fitting**. This operator does not require additional headroom. Additionally, it features standard power limit, soft start and soft stop, very high security and quiet door travel.

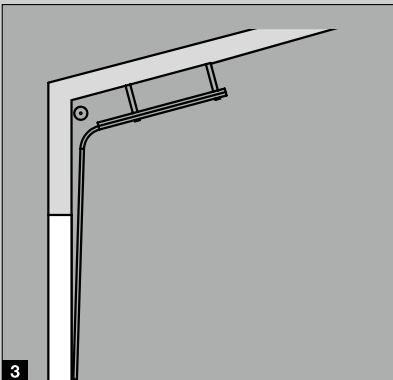

3

Track application HD with inclination

3 4 Track variants for special fitting situations

The industrial sectional door SPU F42 Plus offers a variety of track variants for special fitting situations, e. g. a track application with inclination that you can use to guide your garage sectional door at an incline along the pitched roof of your garage.

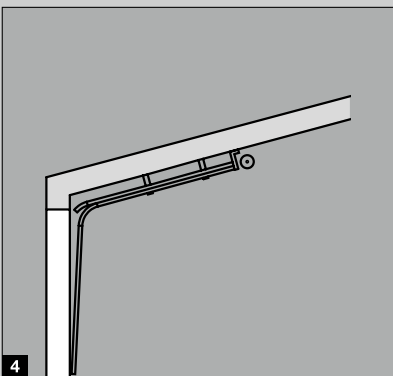

4

Track application LD with inclination

* Without operator light



Additional information can be found in the Industrial Sectional Doors brochure

Outstanding performance characteristics



A well-insulated garage door is always recommended when the garage and the home are directly connected. The ThermoFrame frame connection further improves the already high insulation values of the double-skinned Hörmann sectional garage doors.

This reduces your energy costs.

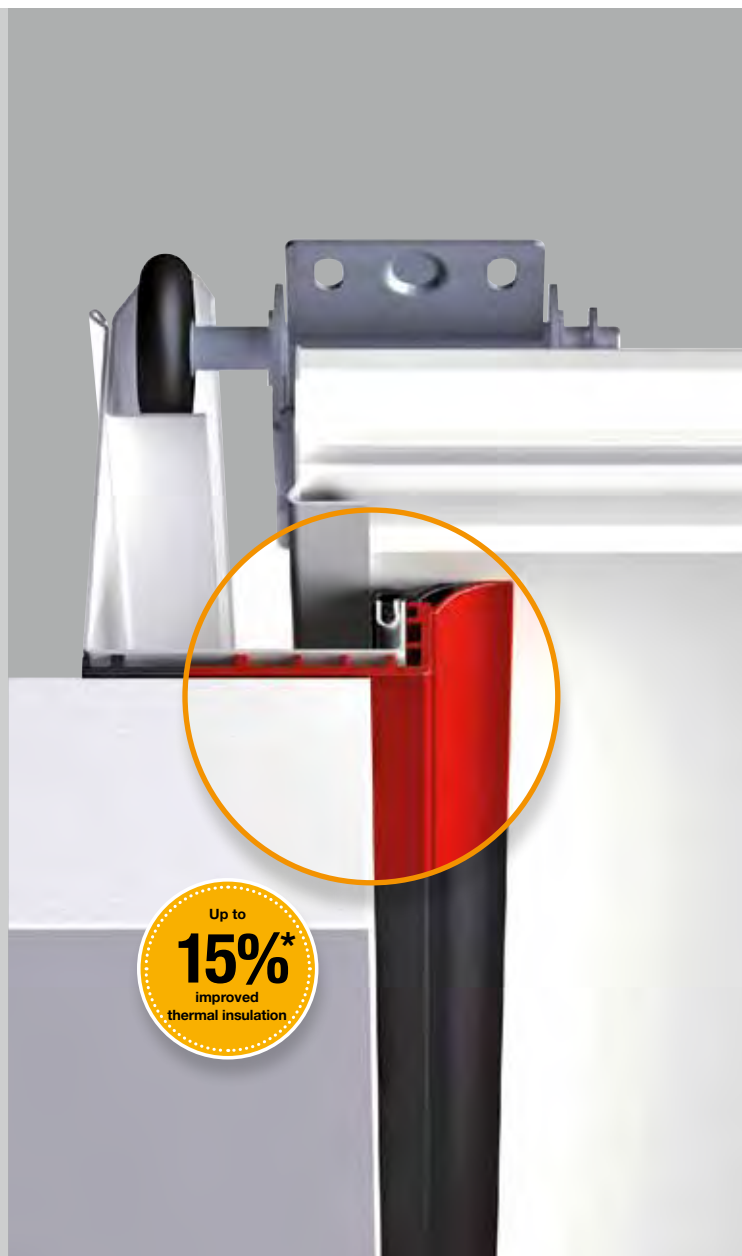

Improved thermal insulation with ThermoFrame

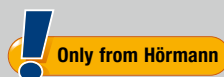

The plastic profile that can be simply fitted together with the door frame, creates a thermal break between the frame and the brickwork, improving the thermal insulation by up to 15%*. In addition, extra lip seals on both sides and in the upper section of the door provide better sealing while lowering the loss of heating energy from the garage interior. The ThermoFrame frame connection is optionally available for all Hörmann sectional garage doors.

* For a double-skinned sectional garage door LPU 42 size 5000 x 2125 mm

Thermal insulation

The thick insulated sandwich sections insulate just as well as a brick wall. This means that your garage is not wasting any energy and is saving you real money.



Acoustic insulation

The excellent acoustic insulation for the LPU sections reduces road traffic noise (approx. 80 dB(A)) to room volume level (approx. 55 dB(A)). So you can do what you want in your garage, whether you want to work in peace or throw a party.



Wind load

The LPU door sections are extremely sturdy so that your door can even withstand wind forces of up to 120 km/h, equivalent to hurricane force, without a problem. This means optimum protection for your garage and everything in it.



Sealing

Your garage is also well protected from heavy rain. Due to the all-around seals between the door leaf and frame as well as the seals between the sections, virtually no rain can penetrate a closed door.



Performance characteristics according to European standard 13241-1

Door type	Thermal insulation	Acoustic insulation	Wind load ⁵⁾	Sealing	
				Air	Water
LPU 67 Thermo		R = approx. 25 dB	Class 3	Class 3 ⁴⁾	Class 3 ³⁾
Section	U = 0.33 W/(m ² ·K)				
Door leaf	U = 0.49 W/(m ² ·K)				
Fitted door ¹⁾	U = 1.0 W/(m ² ·K)				
LPU 42		R = approx. 25 dB	Class 3	Class 3 ⁴⁾	Class 3 ³⁾
Section	U = 0.5 W/(m ² ·K)				
Door leaf	U = 0.9 W/(m ² ·K)				
Fitted door ¹⁾	U = 1.4 W/(m ² ·K)				
LTE 42		R = approx. 20 dB	Class 2	Class 0 ²⁾	Class 0 ²⁾
Door leaf	U = 6.0 W/(m ² ·K)				
Fitted door ¹⁾	U = 6.5 W/(m ² ·K)				
LTH			Class 3	Class 0 ²⁾	Class 0 ²⁾
Door leaf	U = 2.5 W/(m ² ·K)				
Fitted door ¹⁾	U = 3.0 W/(m ² ·K)				

¹⁾ The U-values apply to fitted doors without glazing in the size: 5000 × 2125 mm

²⁾ Doors with ventilation slots, on request classes 2-3

³⁾ Up to 70 Pa water pressure

⁴⁾ Valid for panelled and L-ribbed (LPU 42 doors S-, M-, D- or T-ribbed: class 2)

⁵⁾ Higher wind load classes on request

Track applications

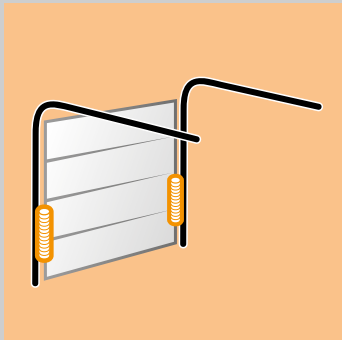

Track application Z

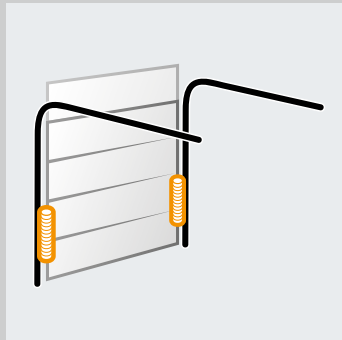

Track application BZ

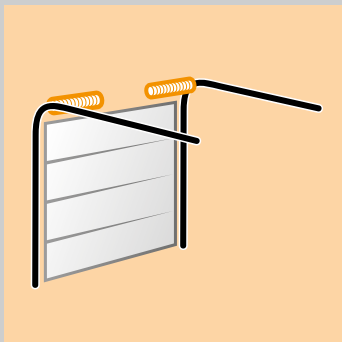

Track application N

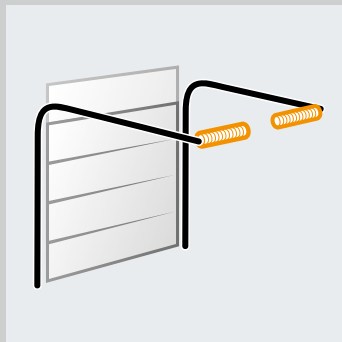

Track application BL

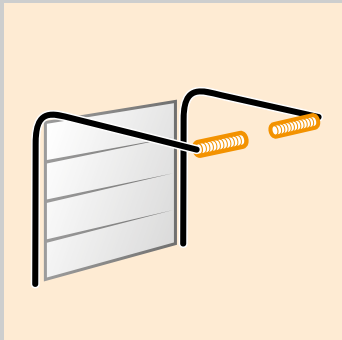

Track application L

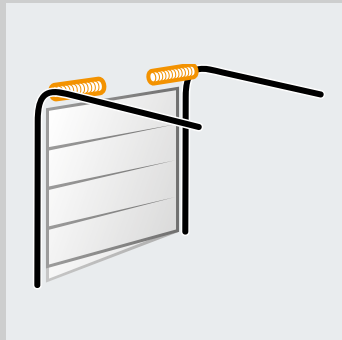

Track application SN

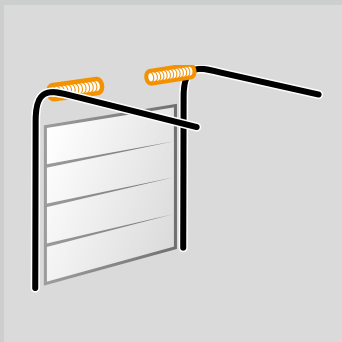

Track application H

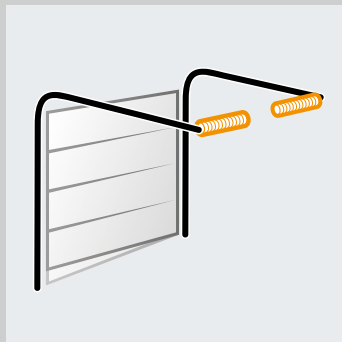

Track application SL

Explanations

If you are interested in this track version for high-lift doors, contact your Hörmann specialist dealer.

LZ Clear frame dimension

RM Grid height

DE Ceiling height

Note: The operator should be fitted 40 mm higher for dark coloured doors which are exposed to the sun.

LDH Clear passage height

GIM Inside garage dimension

ET Distance back

Track applications

Track application Z (not for LTH 42)

Tension spring track application with tension spring assembly

Max. width 3000 mm

Max. height 2625 mm / 2500 mm (LPU 67 Thermo)

Track application N

Normal track application with torsion spring assembly

Max. width 6000 mm

Max. height 3000 mm

Track application L

Low-headroom tracks with torsion spring assembly

Max. width 6000 mm

Max. height 3000 mm

Track application H (not for LPU 67 Thermo)

High-lift track application with torsion spring assembly

Max. width 5500 mm

Max. height 3000 mm

Track application BZ (not for LPU 67 Thermo)

Tension spring track application with tension spring assembly and flush-fitting panels

Max. width 3000 mm

Max. height 3189 mm

Track application BL (not for LPU 67 Thermo)

Low-headroom tracks with torsion spring assembly and flush-fitting panels

Max. width 4000 mm

Max. height 3520 mm

Track application SN (only LPU 42)

Normal track application with torsion spring assembly with chamfered bottom section (max. 300 mm height difference)

Max. width 6000 mm

Max. height 3000 mm

Track application SL (only LPU 42)

Normal track application with torsion spring assembly and high-lift track application with chamfered bottom section (max. 300 mm height difference)

Max. width 6000 mm

Max. height 3000 mm

For further information, please see the fitting data or contact your Hörmann partner.

Horizontal view

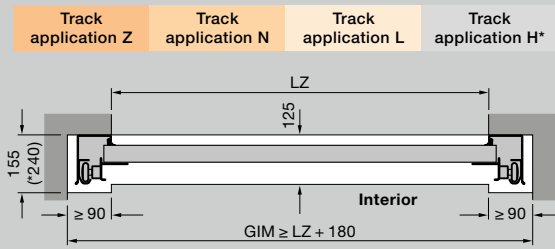

Fitting with track applications Z, N, L

Overall length operators (W)	Track application Z	Track application N	Track application L
Doors with operator			
2125 (K)	3200	3200*	3200
2250 (K)		3200**	
Max. door height			
2375 (M)	3450	3450*	3450
2500 (M)		3450**	
2625 (L)	4125		
3000 (L)		4125	4125

* LPU 67 Thermo
 ** LPU 42, LTE 42

Vertical views (with operator)

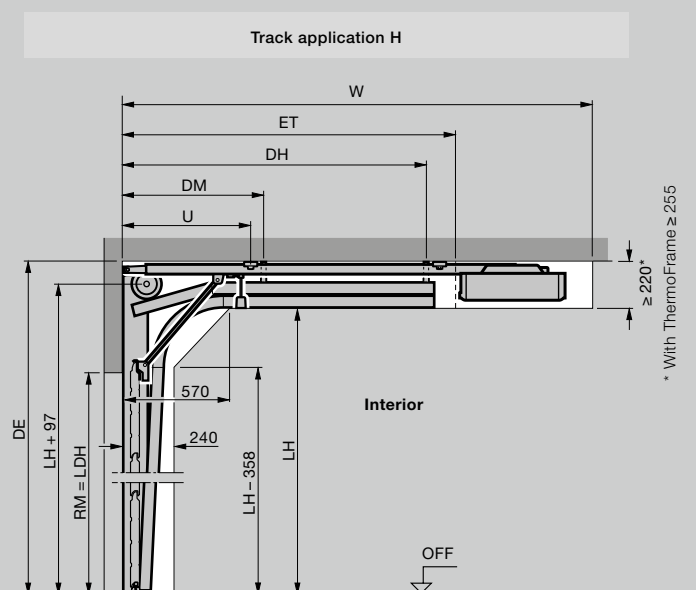
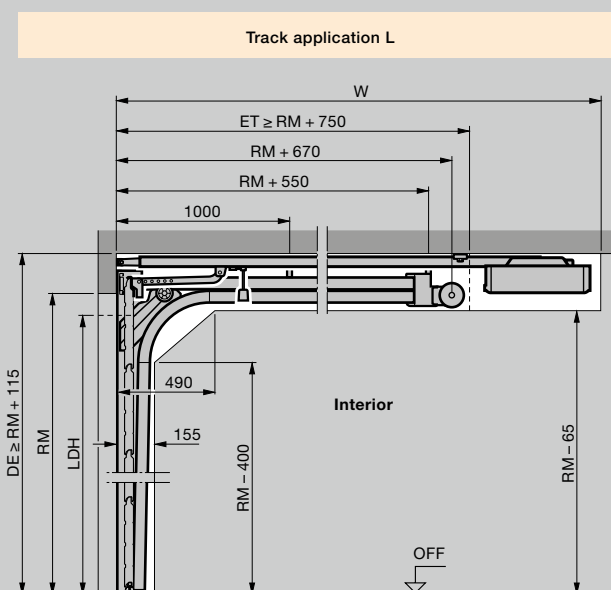
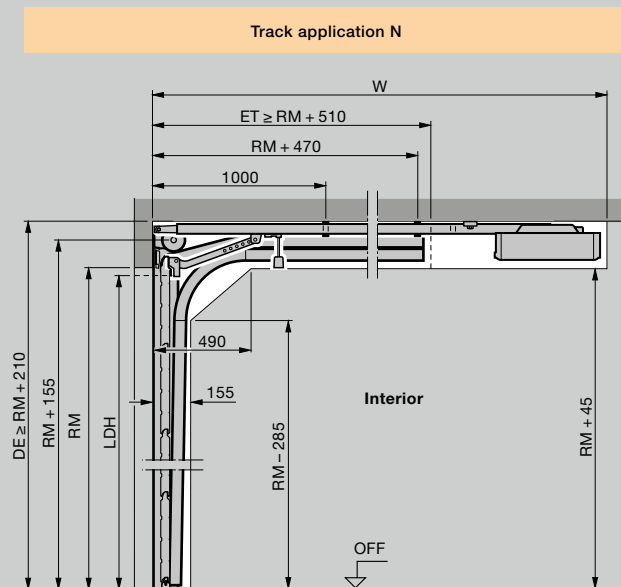
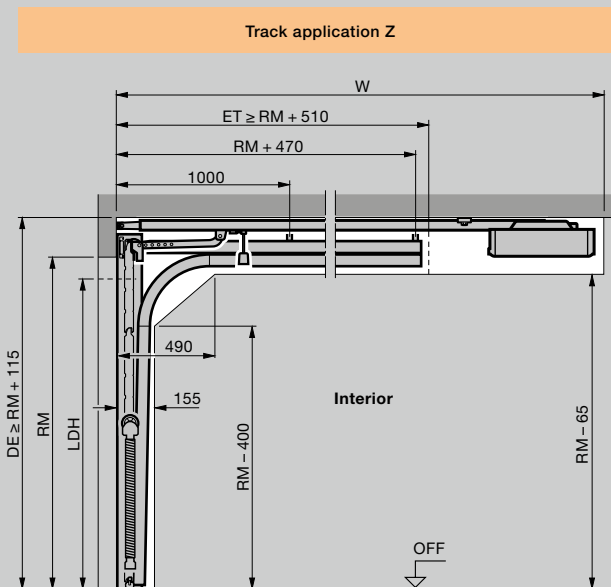

Fitting with flush-fitting panel

Overall length operators (W)	Track application BZ	Track application BL
Doors with operator		
	2125 (K)	3272
	2375 (M)	3522
Max. door height	2625 (L)	4197
	3000 (L)	4197

Vertical views

Track application BZ Track application BL Without lintel

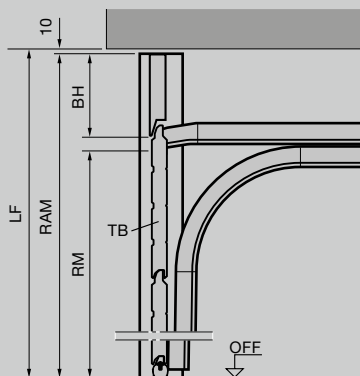

Track application BZ Track application BL With lintel

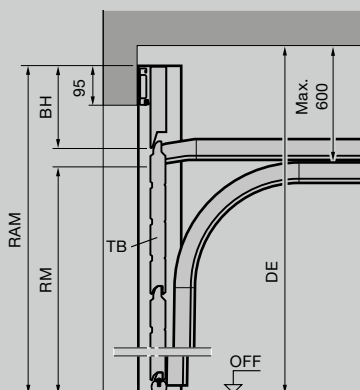

Dimensions in mm

Explanations

Drive booms

- K Short boom
- M Medium boom
- L Long boom

Track applications

- Z Tension spring track application
- N Normal track application
- L Low headroom track application
- H High-lift track application
- BZ Tension spring track application with flush-fitting panels
- BL Low-lintel track application with flush-fitting panels

Ordering sizes

- LZ Clear frame dimension
- RM Grid height
- RAM Overall frame dimension (of flush-fitting panels)
 - Min. = RM + 190 mm
 - Max. = RM + door section height
- W Overall length with operator
- LF Structural opening
- DE Ceiling height

Note: The operator should be fitted 40 mm higher for dark coloured doors which are exposed to the sun.

- LDH Clear passage height
See table on page 88
- GIM Inside garage dimension
- ET Distance back
- TB Door leaf
- BH Panel height
- LH Track height
- DM Ceiling suspension, centre
- DH Ceiling suspension, back
- OFF Finished floor level

Note

Before fitting a sectional door, the structural openings must be finished and the floors be laid and level. The clearance required for fitting the door must be free of supply lines, heater fans, etc.

For further information, please see the fitting data or contact your Hörmann partner.

SIZES AND FITTING DATA FOR LPU 42 DOORS WITH WICKET DOORS

Doors with wicket doors with ribbing

Size range

Door grid height (RM)	Door grid width (LZ)													
	2250	2375	2500	2750	3000	3250	3500	3750	4000	4250	4500	4750	5000	
3000														
2875	○	○	○	○	○	○	○	○	○					
2750														
2625	○	○	○	○	○	○	○	○	○	○	○			
2500														
2375														
2250														
2205														
2125														
2080														
2000														
1955														
1875														

Wicket doors with ribbing

Clear passage height		Lever height from OFF
Without glazing	With glazing	
1955	1955	831
1871	1871	799
2155	2155	906
2055	2055	868
1955	1955	831
1855	1855	793
2123	2203	924
2075	2155	906
1999	2079	877
1955	2035	861
1875	1955	831
1827	1907	813
1747	1827	782

Doors with wicket doors with panels

Size range

Door grid height (RM)	Door grid width (LZ)							
	2250	2500	2750	3000	3250	3500	3750	4000
3000								
2875	□	□	□	□	□	□	□	□
2750	□	□	□	□	□	□	□	□
2625	□	□	□	□	□	□	□	□
2500								
2375								
2250								
2205	□	□	□	□	□	□	□	□
2125								
2080	□	□	□	□	□	□	□	□
2000								
1955	□	□	□	□	□	□	□	□

Wicket doors with panels

Clear passage height	Lever height from OFF
1955	831
1871	799
2155	906
2055	868
1955	831
1855	793
2203	924
2155	906
2079	877
2035	861
1955	831
1907	813

○ = Not possible with Decograin, Micrograin Sandgrain and Silkgrain

□ = Not possible with Decograin

Horizontal view

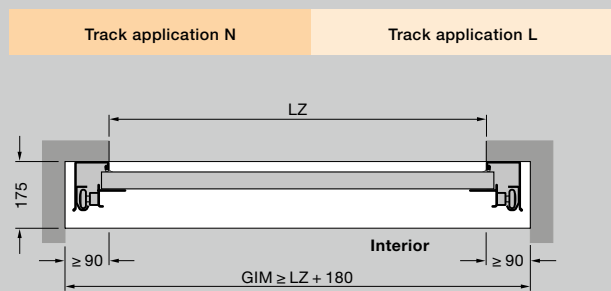

Vertical views

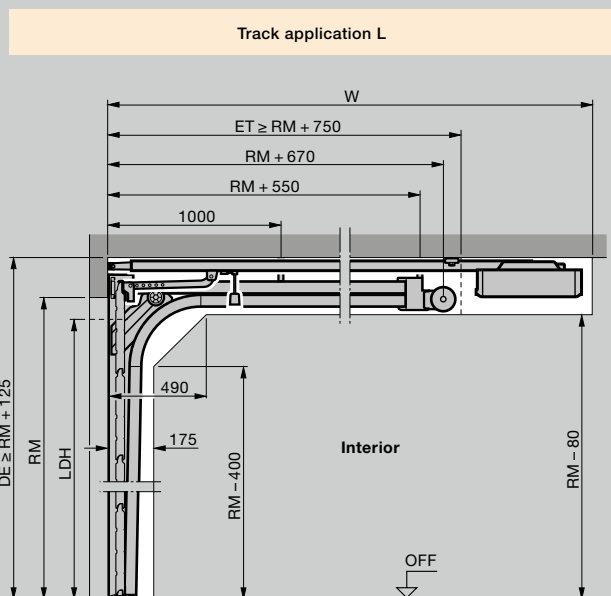
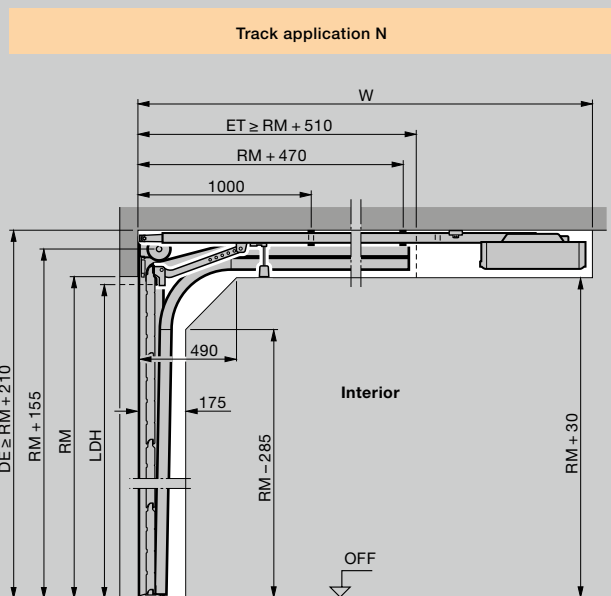

Dimensions in mm

Explanations

Track applications

- N Normal track application
- L Low headroom track application

Ordering sizes

- LDB Clear passage width
- LZ Clear frame dimension
- RM Grid height
- W Overall length with operator

DE Ceiling height

Track application N:

- Manual operation $\geq RM + 210$ mm
- With operator $\geq RM + 210$ mm
- With operator and ThermoFrame $\geq RM + 255$ mm

Track application L:

- Manual operation $\geq RM + 100$ mm
- With operator $\geq RM + 115$ mm
- With operator and ThermoFrame $\geq RM + 145$ mm

LDH Clear passage height

Track application N:

- Manual operation = $RM - 50$ mm
- With operator = $RM = LDH$

Track application L:

- Manual operation = $RM - 100$ mm
- With operator = $RM - 30$ mm ($LZ \leq 3000$)
- With operator = $RM - 80$ mm ($LZ > 3010$)

GIM Inside garage dimension

ET Distance back

OFF Finished floor level

Fitting with ThermoFrame

- Fitting with ThermoFrame $LDB = LZ - 12$ mm
- Fitting with ThermoFrame and frame covering (set 1-3) $LDB = LZ - 15$ mm

Note

The opening height must not be less than the ordering size of the garage door (RM), otherwise the wicket door will not open.

SIZES AND FITTING DATA FOR SIDE DOORS

Horizontal views

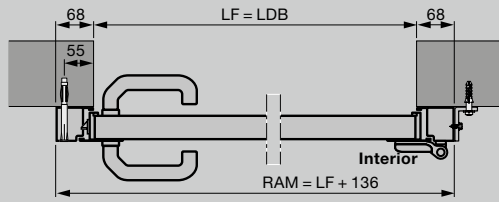

Side door with aluminium block frame, profile type 1
Fitting behind the opening

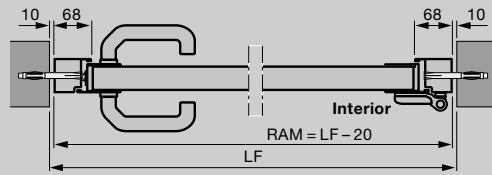

Side door with aluminium block frame, profile type 2
Fitting in the opening

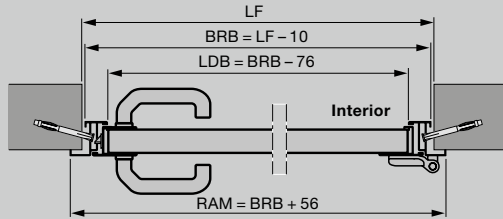

Side door with aluminium corner frame,
profile type 1 or 2
Internal fitting

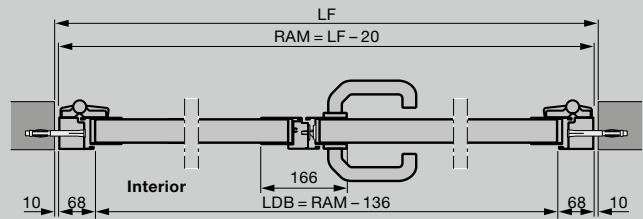

Double-leaf side door with aluminium block frame, profile type 2
Fitting in the opening

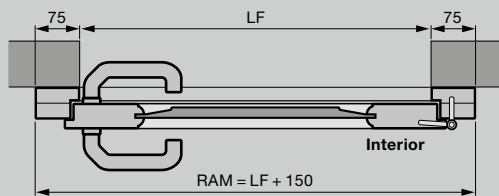

Solid timber side door
Fitting behind the opening

- Double-leaf side door with asymmetrical division
- Double-leaf side door opening outwards

Vertical views

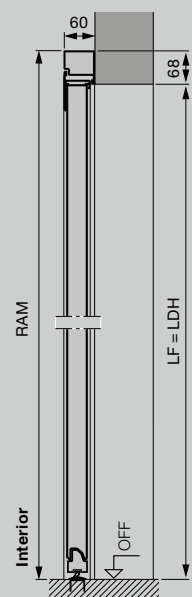

Side door with aluminium
block frame, profile type 2
Fitting behind the opening

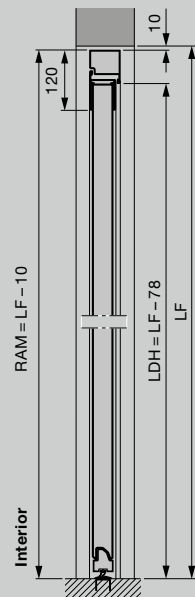

Side door with aluminium
block frame, profile type 2
Fitting in the opening

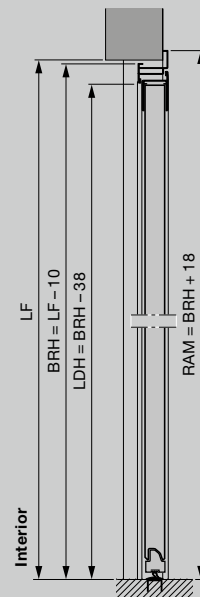

Side door with aluminium
corner frame, profile type 2
External fitting

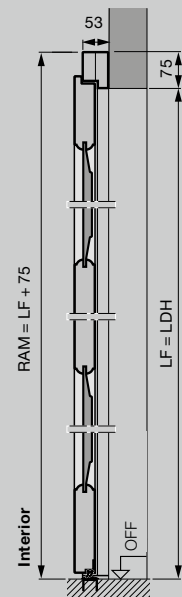

Solid timber side door
Fitting behind the opening

Steel side doors

Profile type 1 (fitting behind the opening) with S-, M-, L-ribbing, S-panelled, block frame

Structural opening	Ordering size = RAM	Lever height* from OFF	Door section height B
855 – 875 × 1990 – 2000	990 × 2058	955	500
855 – 875 × 2115 – 2125	990 × 2183	1010	531
980 – 1000 × 1990 – 2000	1115 × 2058	955	500
980 – 1000 × 2115 – 2125	1115 × 2183	1010	531

Profile type 2 (fitting behind the opening) with S-, M-, L-, D-, T-ribbing, S-panelled, block frame

Structural opening	Ordering size = RAM	Lever height* from OFF	Door section height B
855 – 875 × 1990 – 2000	990 × 2058	1050	500
855 – 875 × 2115 – 2125	990 × 2183	1050	531
980 – 1000 × 1990 – 2000	1115 × 2058	1050	500
980 – 1000 × 2115 – 2125	1115 × 2183	1050	531

Profile type 2 (fitting in the opening) with S-, M-, L-, D-, T-ribbing, block frame

Structural opening	Ordering size = RAM	Lever height* from OFF	Door section height B
875 × 2000	855 × 1990	1050	500
875 × 2125	855 × 2115	1050	531
1000 × 2000	980 × 1990	1050	500
1000 × 2125	980 × 2115	1050	531

Profile type 1 (only opening inwards, internal fitting) with S-, M-, L-ribbing, S-panelled, corner frame

Ordering size = BRM	Lever height* from OFF	Door section height B
875 × 2000	955	500
875 × 2125	1010	531
1000 × 2000	955	500
1000 × 2125	1010	531

Profile type 2 (internal or external fitting) with S-, M-, L-, D-, T-ribbing, corner frame

Ordering size = BRM	Lever height* from OFF	Door section height B
875 × 2000	1050	500
875 × 2125	1050	531
1000 × 2000	1050	500
1000 × 2125	1050	531

Solid timber side doors

Ordering size = RAM	Structural opening	Lever height* from OFF
Fitting behind the opening (S-, M-, L-ribbed, panel)		
1005 × 2190	855 – 875 × 2115 – 2125	1050
1130 × 2190	980 – 1000 × 2115 – 2125	1050

Fitting behind the opening (style 401, 403, 404, 405)

1130 × 2190	980 – 1000 × 2115 – 2125	1050
-------------	--------------------------	------

Dimensions in mm

Explanations

P1 Profile type 1 (narrow surround)
P2 Profile type 2 (broad surround)

LDB Clear passage width
LDH Clear passage height
RAM Overall frame dimension
LF Structural opening
BRM Nominal size
BRB Nominal size - width
BRH Nominal size - height
OFF Finished floor level

Special sizes

Single-leaf side doors on request
Double-leaf side doors:
1330 – 2500 × 1960 – 2558 mm

* You can find the lever heights for special sizes in the technical manual.

For further information, please see the fitting data or contact your Hörmann partner.

Hörmann: Quality without Compromise



Hörmann KG Amshausen, Germany



Hörmann KG Antriebstechnik, Germany



Hörmann KG Brandis, Germany



Hörmann KG Brockhagen, Germany



Hörmann KG Dissen, Germany



Hörmann KG Eckelhausen, Germany



Hörmann KG Freisen, Germany



Hörmann KG Ichttershausen, Germany



Hörmann KG Werne, Germany



Hörmann Alkmaar B.V., Netherlands



Hörmann Legnica Sp. z o.o., Poland



Hörmann Beijing, China



Hörmann Tianjin, China



Hörmann LLC, Montgomery IL, USA



Hörmann Flexon LLC, Burgettstown PA, USA



Shakti Hörmann Ltd., India

Hörmann is the only manufacturer worldwide that offers you a complete range of all major building products from one source. We manufacture in highly-specialised factories using the latest production technologies. The close-meshed network of sales and service companies throughout Europe, and activities in the USA and Asia, make Hörmann your strong partner for first-class building products, offering "Quality without Compromise".

GARAGE DOORS
OPERATORS
INDUSTRIAL DOORS
LOADING EQUIPMENT
HINGED DOORS
DOOR FRAMES